



Elektrotechnika i elektronika

Wykład 2

Dr inż.
Patrik Król

v2021/1

1 / 41



Wykład 2

- Pole elektromagnetyczne
- Podstawowe podzespoły cd.: przekaźnik (elektromagnes), tranzystory
- Prąd stały, prąd zmienny
- Silniki elektryczne
- Prądnice
- Karta charakterystyki – co to jest i jak czytać

Pole elektromagnetyczne

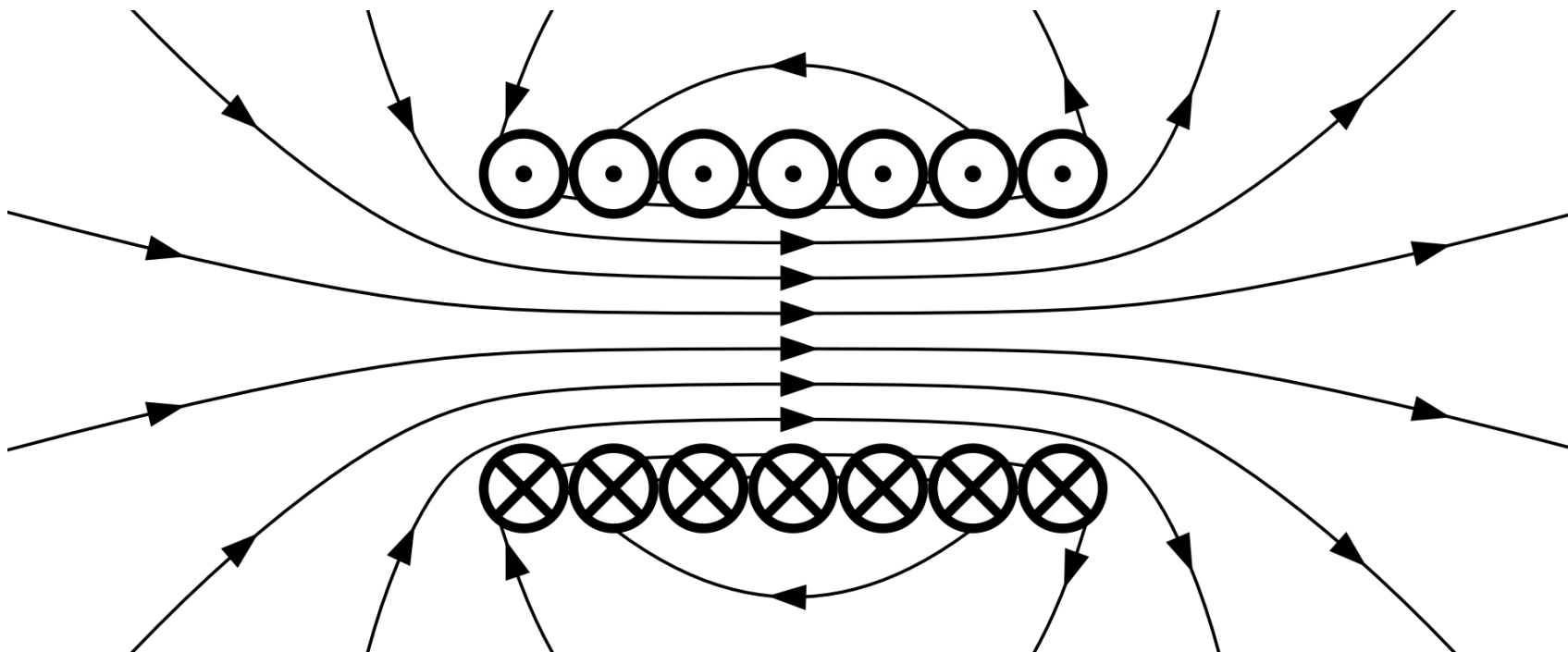

Źródło: https://en.wikipedia.org/wiki/Electromagnetic_field

Cewka



loudspeakershop.eu

Elektromagnes



Gdzie jeszcze może być wykorzystywane to zjawisko?



Źródło: electricmobile.pl

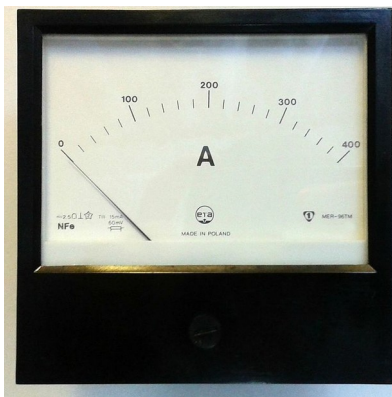

Źródło: <https://pl.wikipedia.org/wiki/Amperomierz>

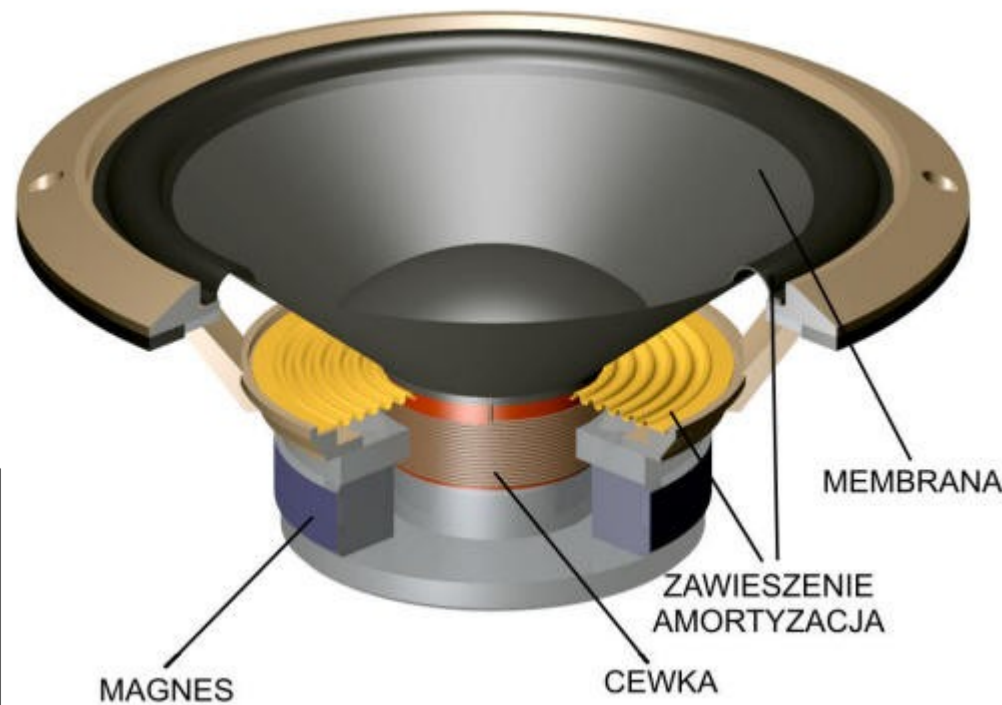
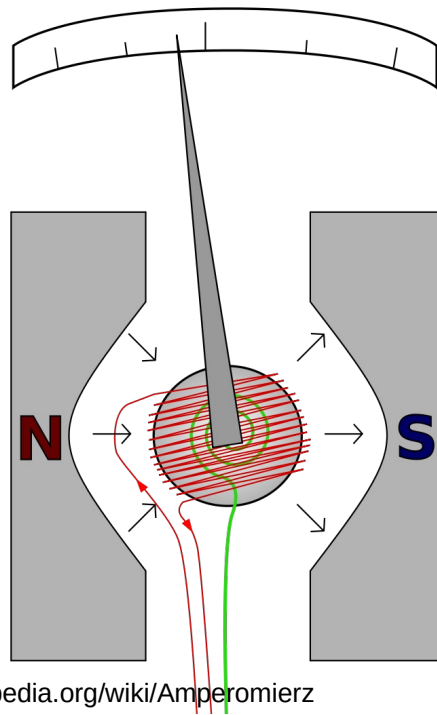

Źródło: https://eduinf.waw.pl/inf/prg/009_kurs_avr/2015.php

Stycznik

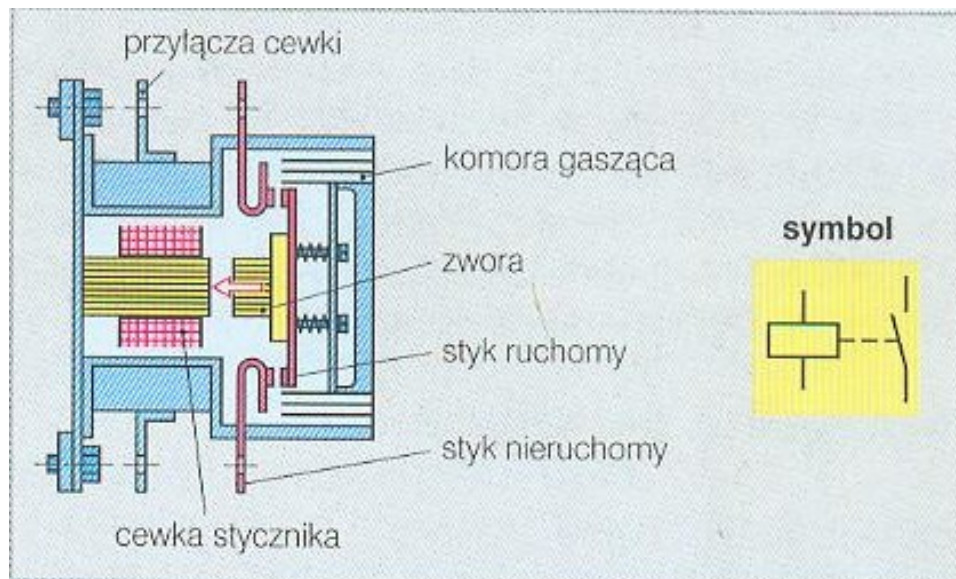

Przełącznik

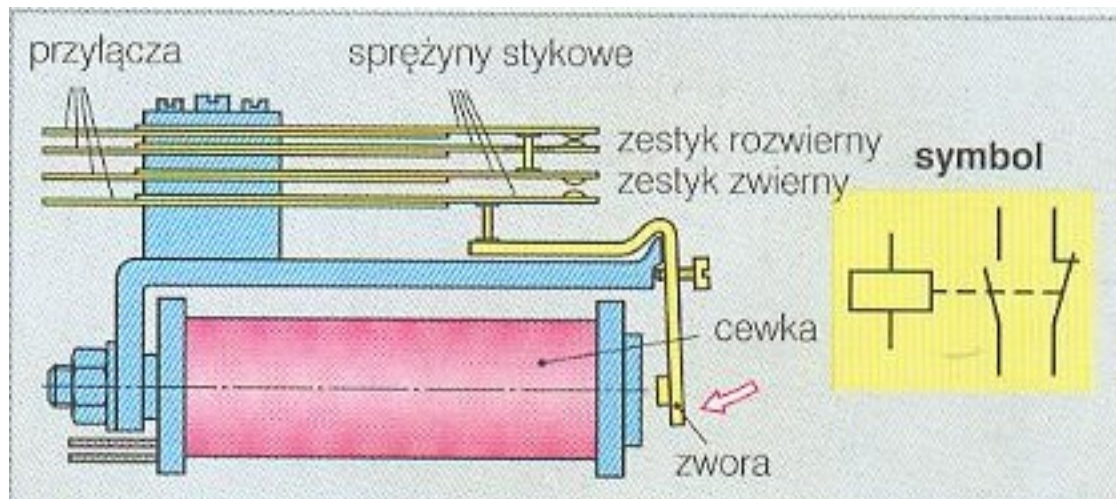

Przełącznik

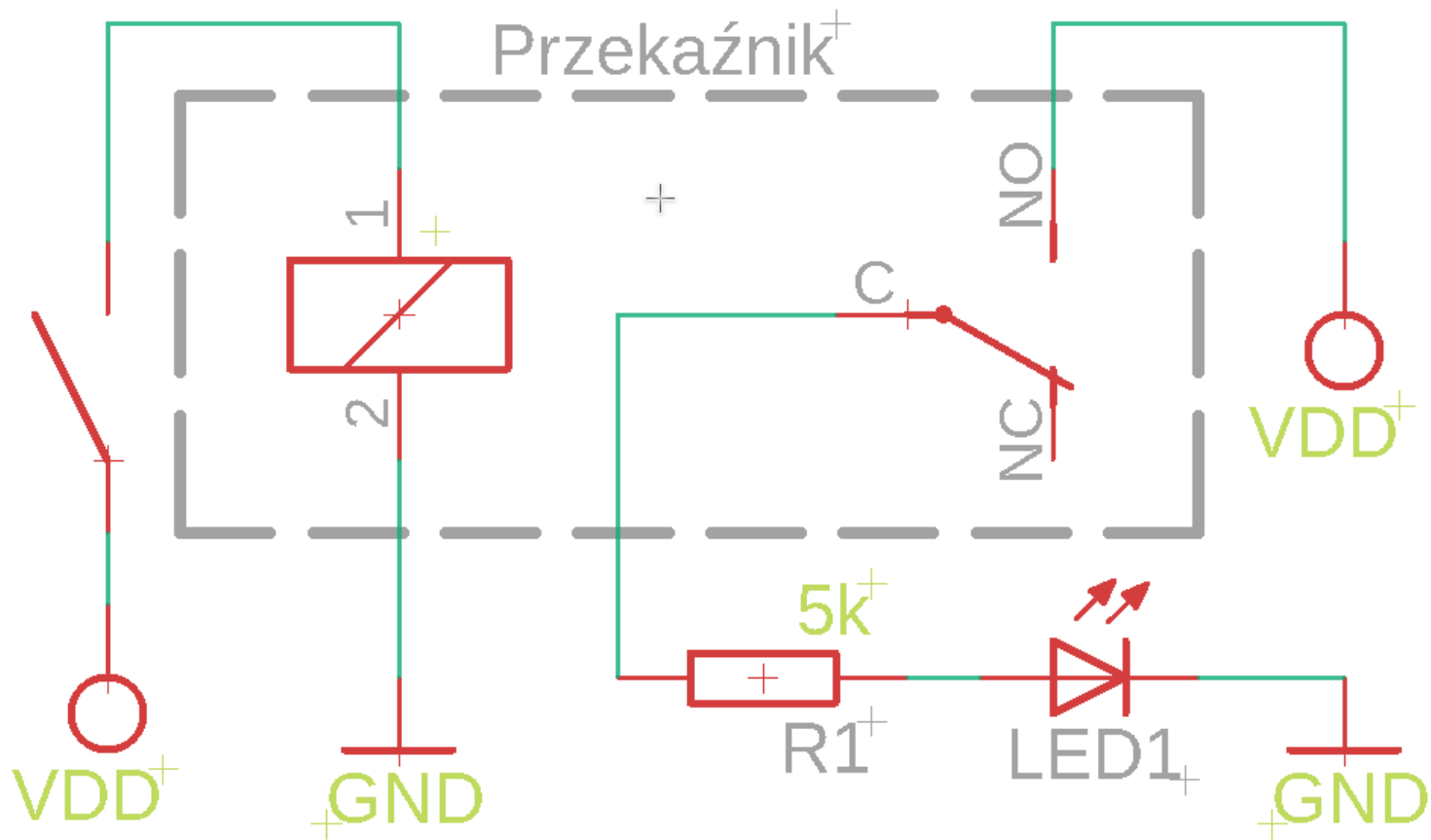

Tranzystory - historia



Replika pierwszego działającego tranzystora z 1947

(Źródło: <https://pl.wikipedia.org/wiki/Tranzystor>)

Dygresja: o procesorach



Rok 1999: Intel Pentium III,
9.5 + 25 milionów tranzystorów

(źródło: <https://www.purepc.pl/pamietacie-intel-pentium-iii-pierwszy-model-pojawil-sie-20-lat-temu>)

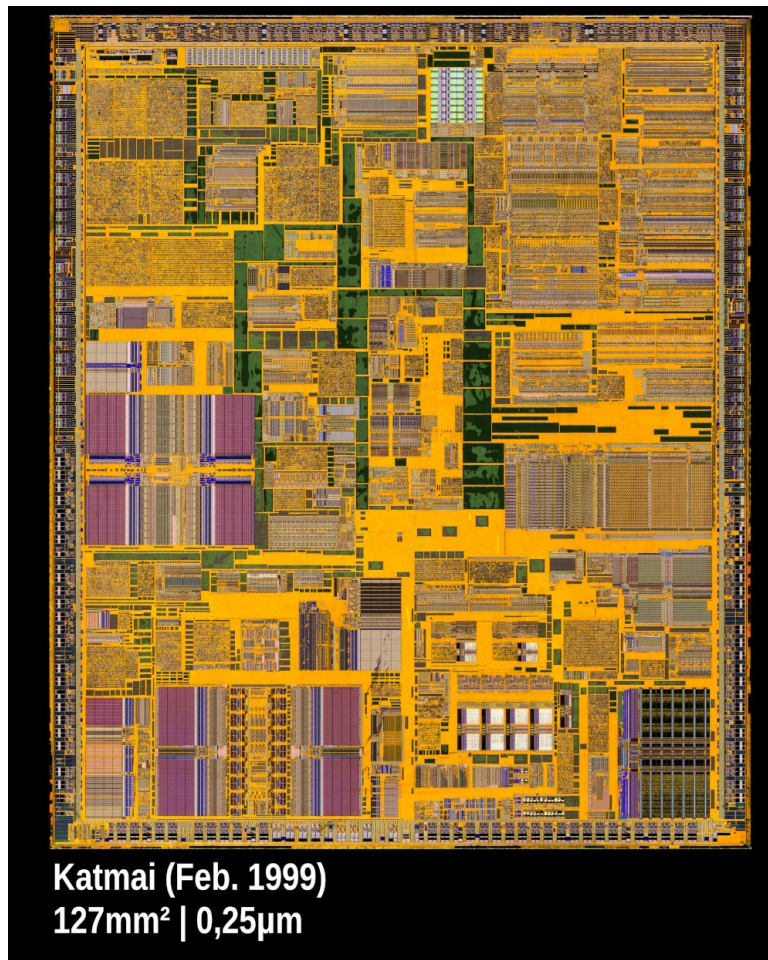

Katmai (Feb. 1999)
127mm² | 0,25µm

Źródło: <https://www.flickr.com/photos/130561288@N04/37346274254/in/album-72157650403404920/>

Dla ciekawskich:

<https://pl.wikipedia.org/wiki/Fotolitografia> + YT

Tranzystory – terazniejszość?

Moore's Law – The number of transistors on integrated circuit chips (1971-2018)

Moore's law describes the empirical regularity that the number of transistors on integrated circuits doubles approximately every two years. This advancement is important as other aspects of technological progress – such as processing speed or the price of electronic products – are linked to Moore's law.

OurWorld
in Data

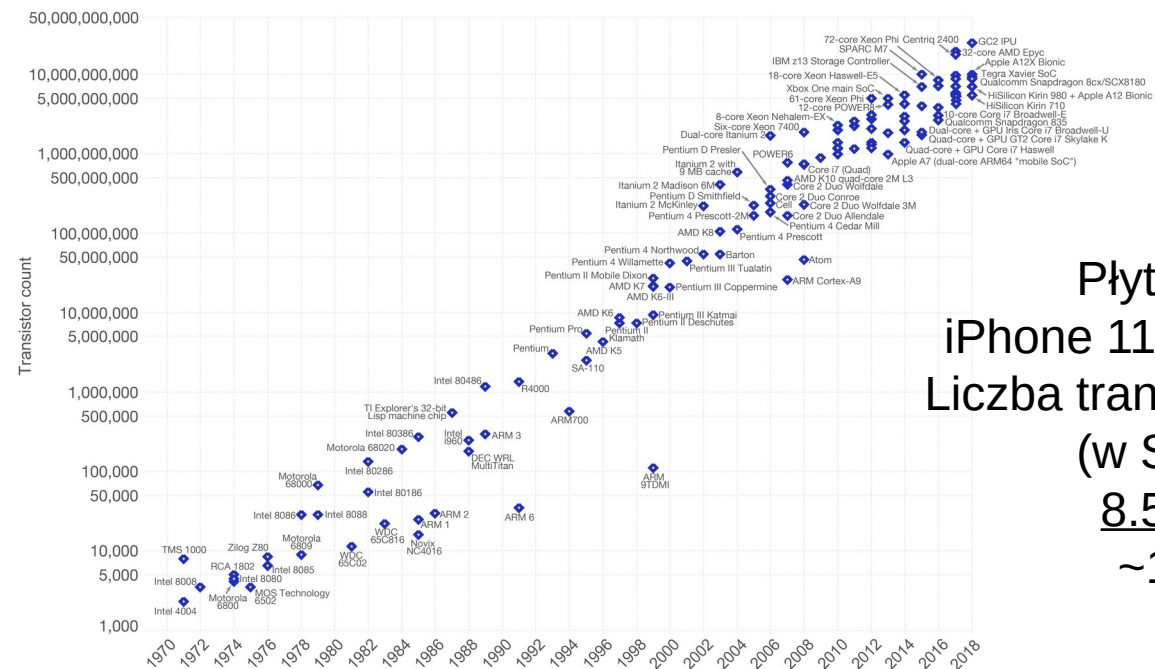

Data source: Wikipedia (https://en.wikipedia.org/wiki/Transistor_count)
The data visualization is available at OurWorldinData.org. There you find more visualizations and research on this topic.

Licensed under CC-BY-SA by the author Max Roser.

Płyta główna
iPhone 11 Pro Max
Liczba tranzystorów
(w Soc A13):
8.5 miliarda
~100 mm²

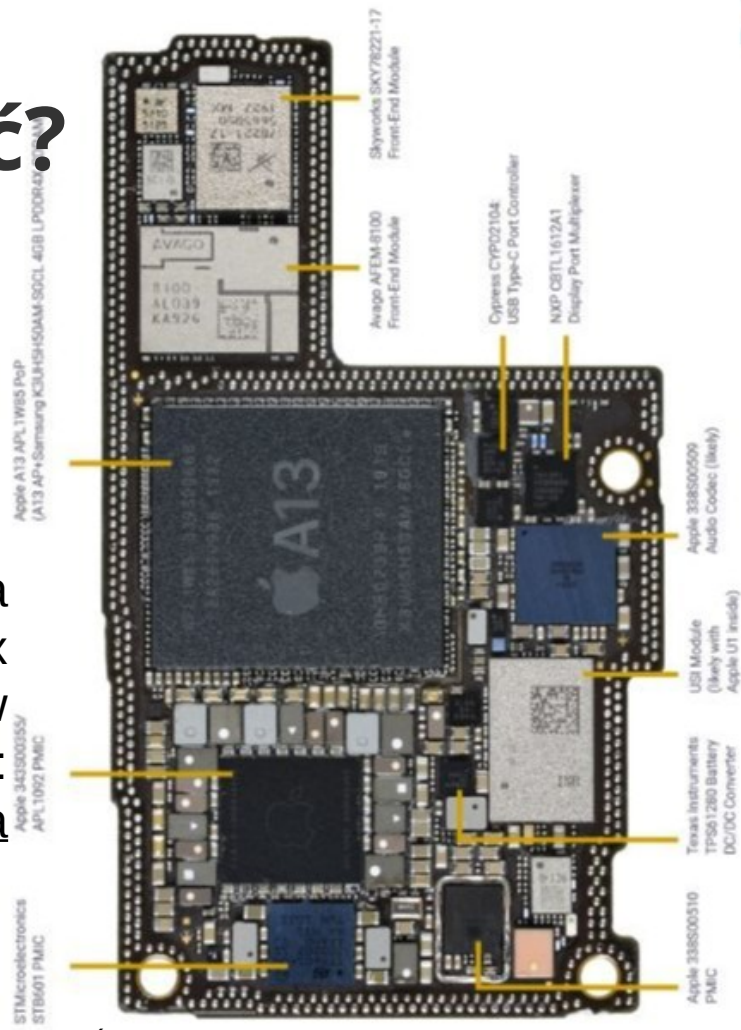

Źródło: <https://www.vw01.net/en/archives/19185>

Źródło: https://en.wikipedia.org/wiki/Transistor_count

Co robi tranzystor?



Źródło: <https://www.piekarz.pl/25377-przelacznik-kn3-b-101/>



Źródło: https://en.wikipedia.org/wiki/Audio_power_amplifier

Tranzystor jako włącznik

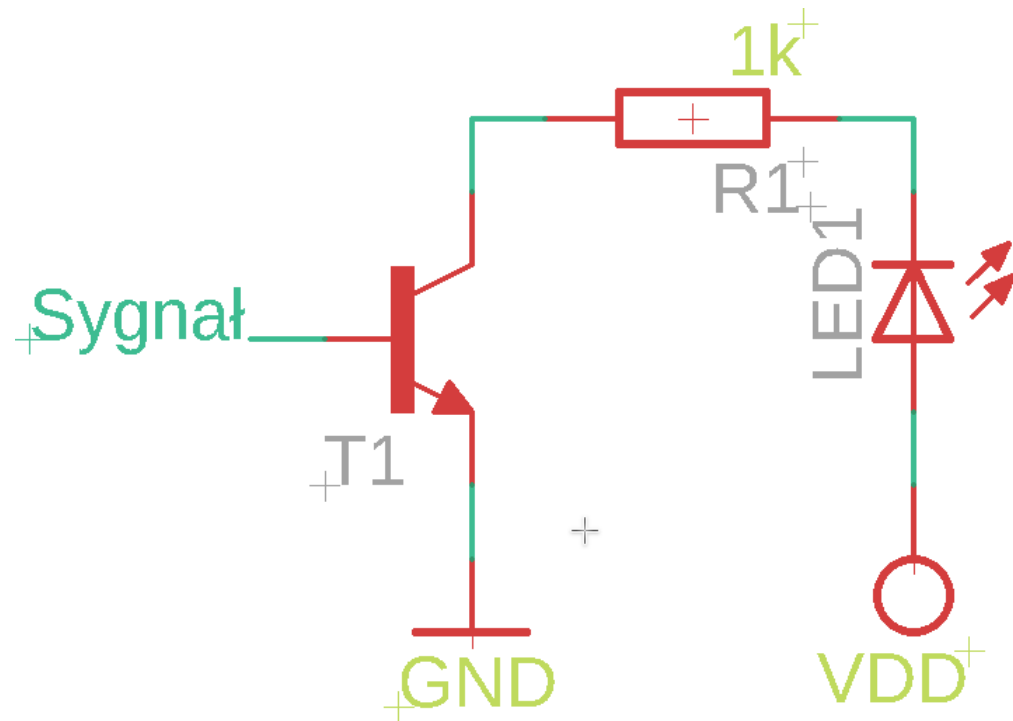
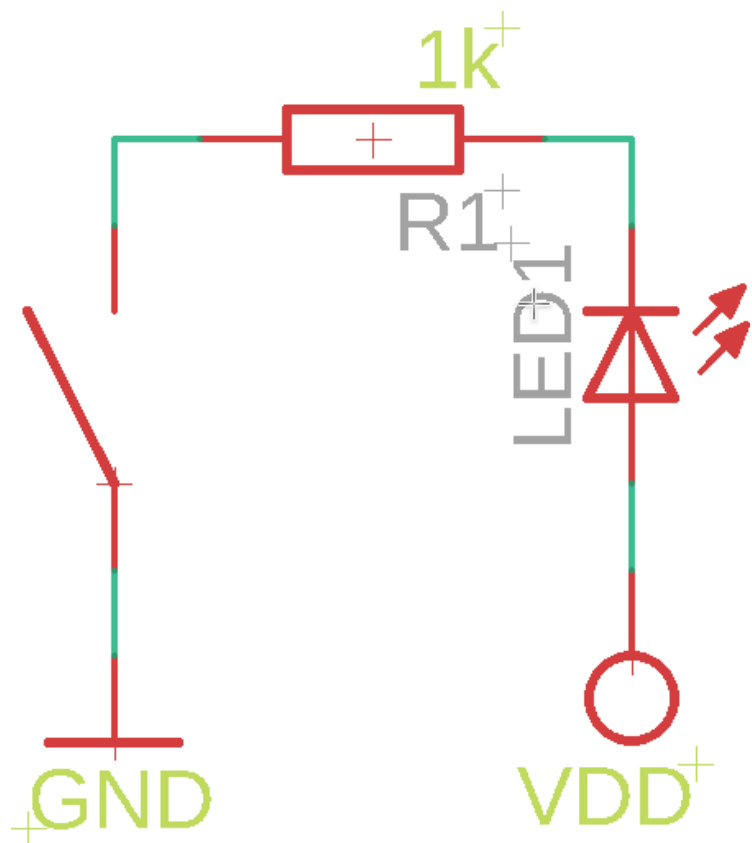

NPN i PNP

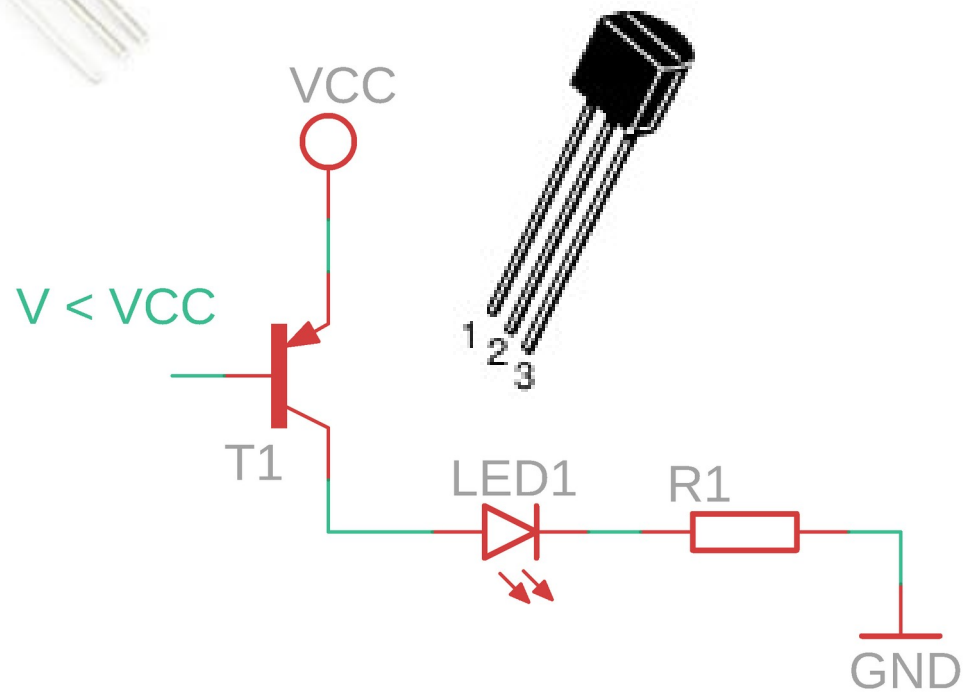
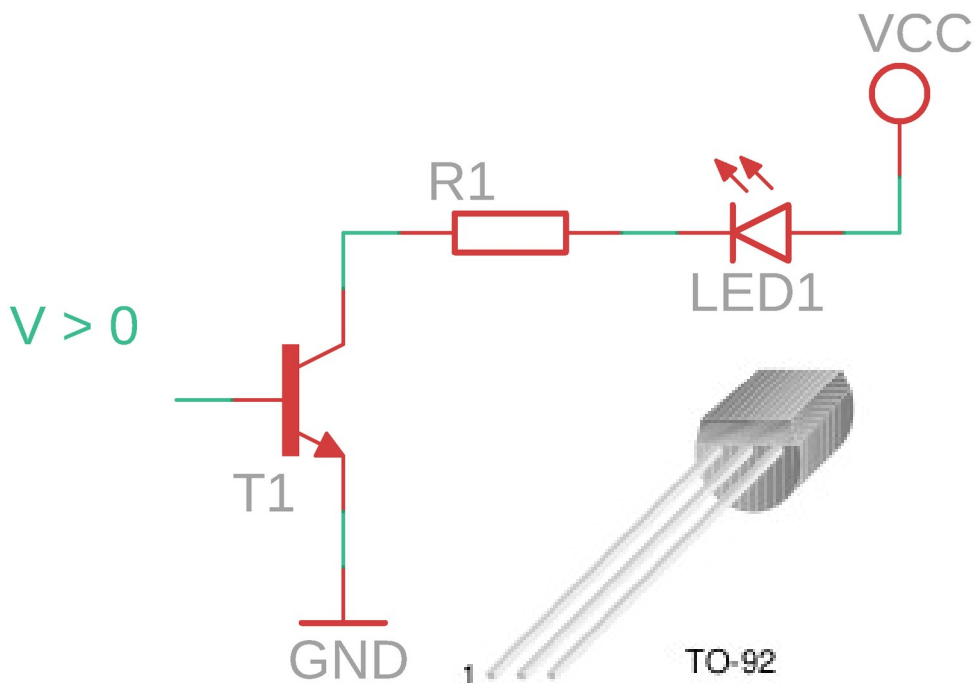
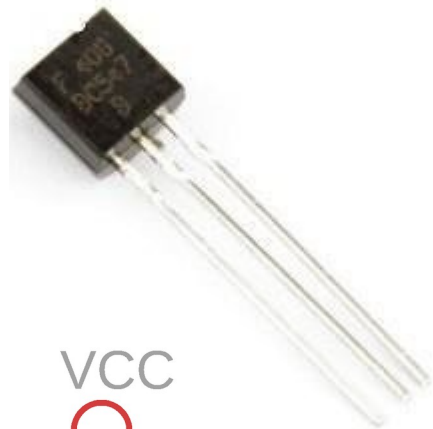

Inne obudowy



Jak działa tranzystor?

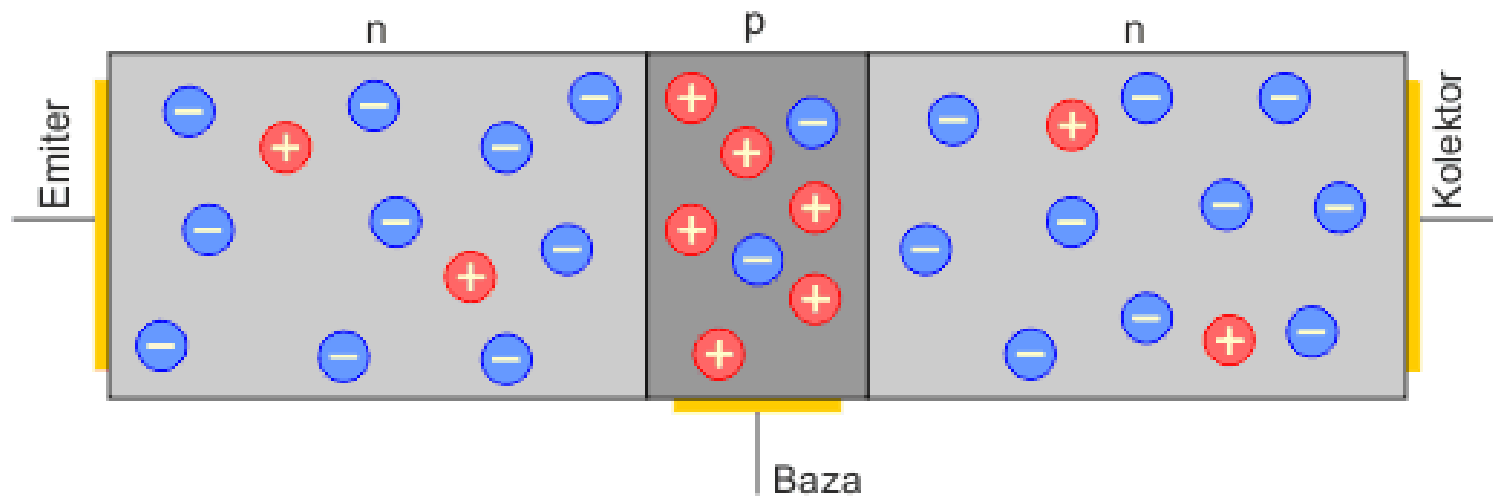

Prąd stały i prąd zmienny

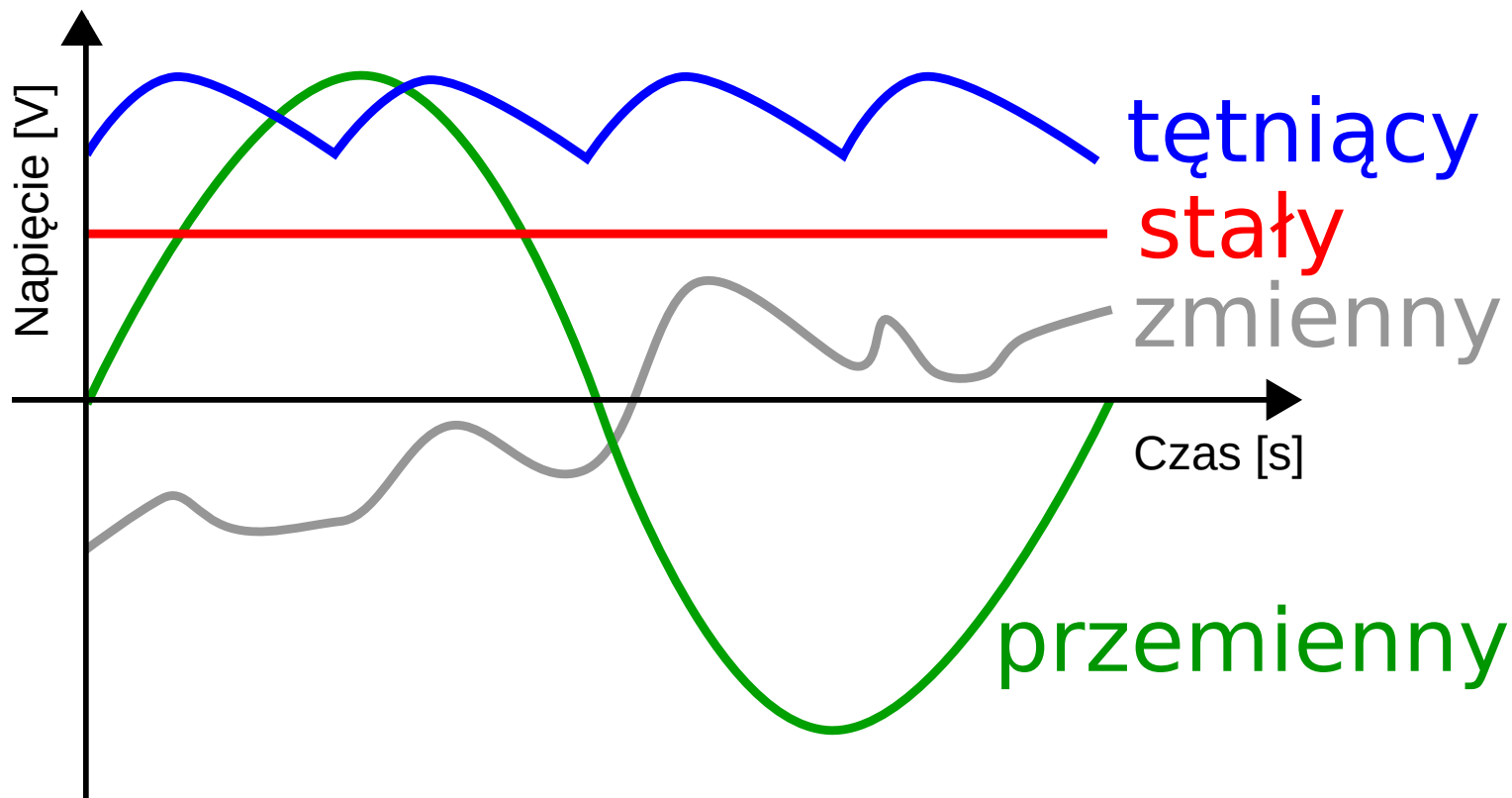

Prąd jedno- i trójfazowy

Jednofazowy



Trójfazowy

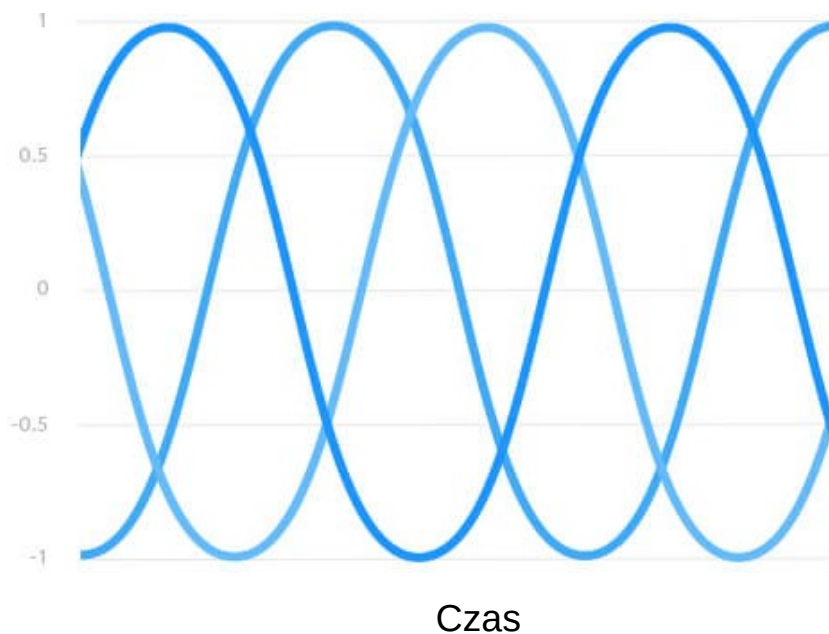

Napięcie znamionowe a skuteczne

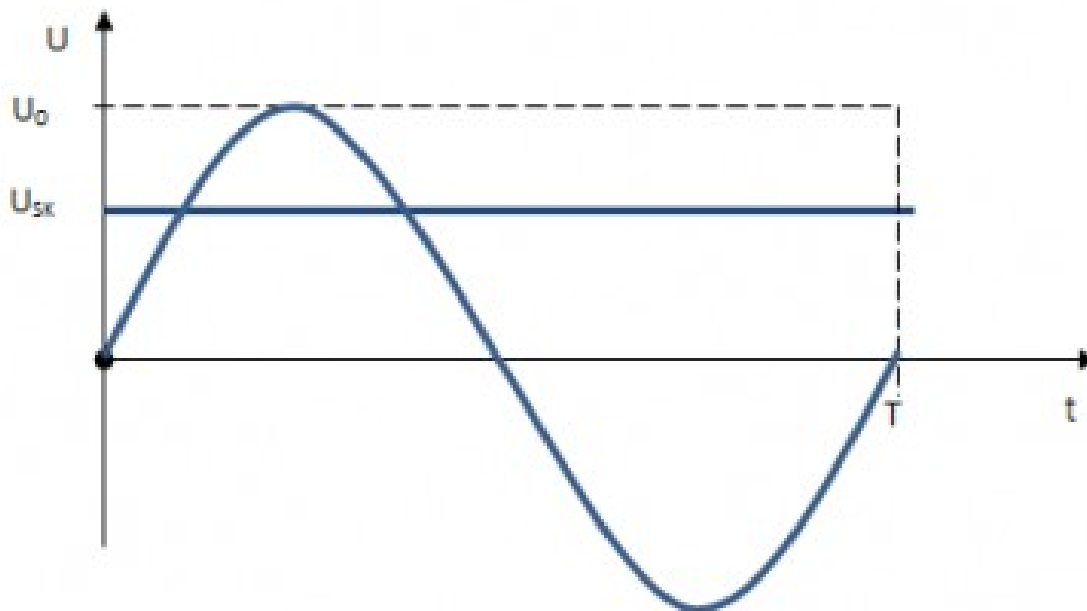

$$U_{sk} = \frac{U_0}{\sqrt{2}}$$

U_0 – amplituda napięcia (wartość szczytowa)

U_{sk} – napięcie skuteczne

Do czego używa się prądu zmiennego?

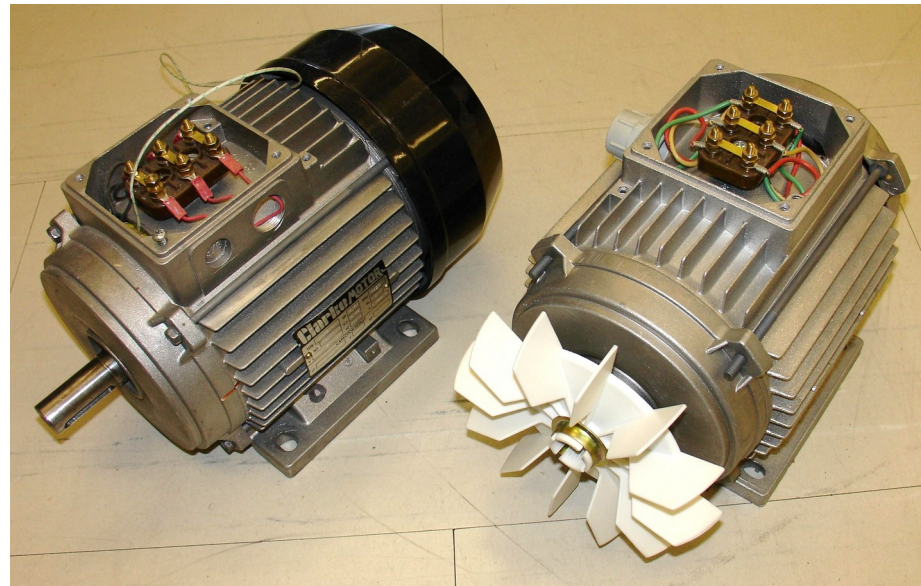
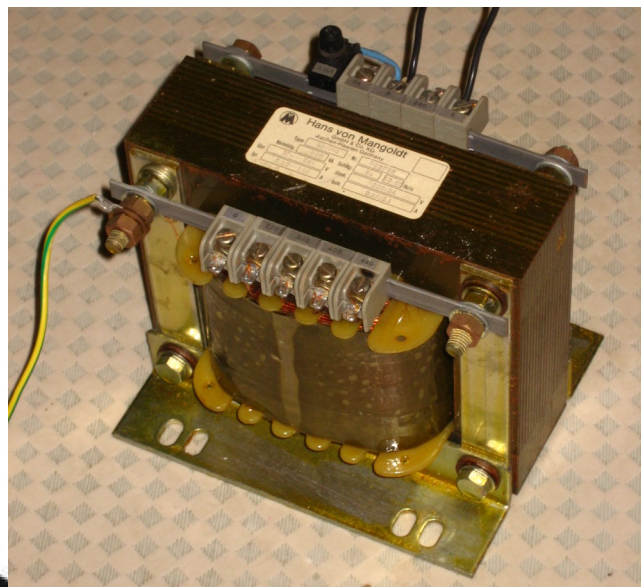
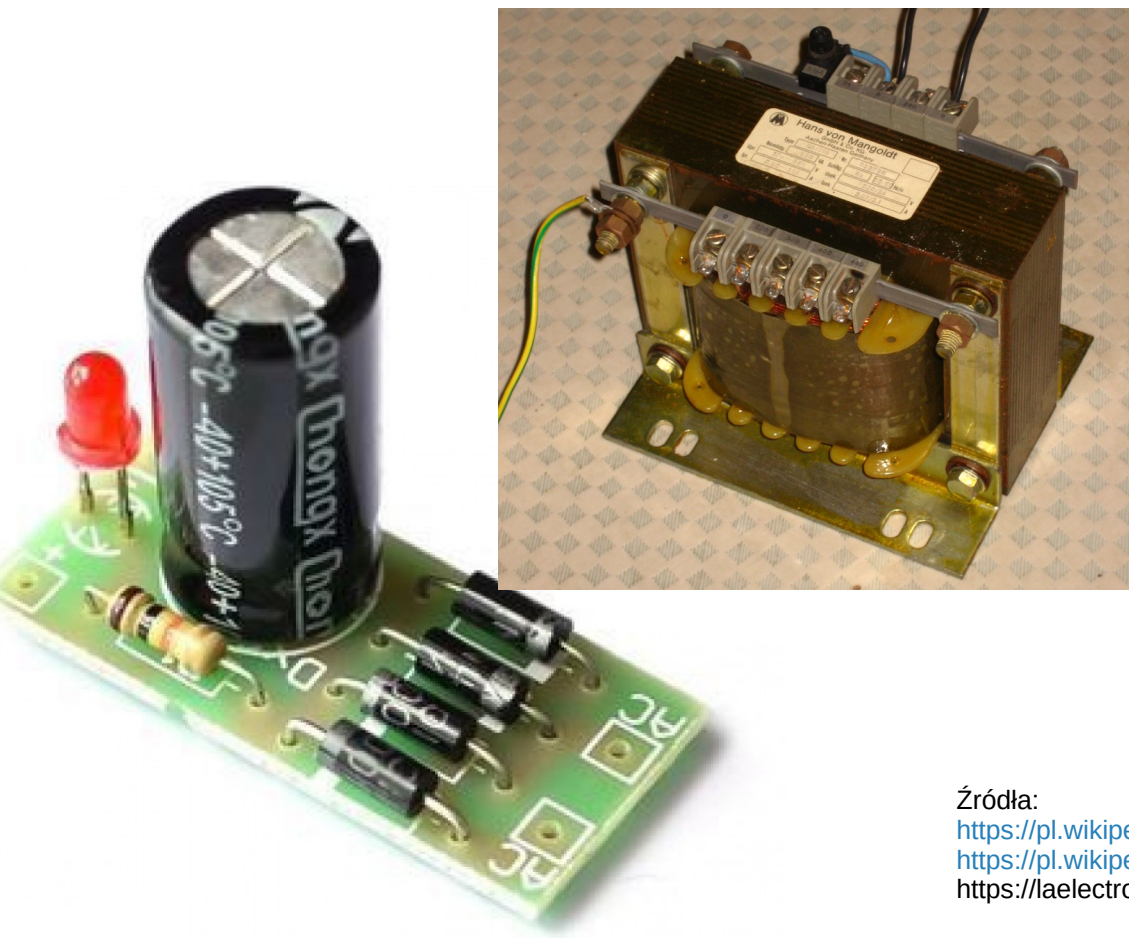

Źródła:

https://pl.wikipedia.org/wiki/Silnik_elektryczny

<https://pl.wikipedia.org/wiki/Transformator>

<https://laelectronica.com.gt/modulo-rectificador-de-ac-dc-de-6v16v-1a>

Silniki elektryczne

- Silniki komutatorowe (szczotkowe)
 - Szeregowy,
 - Bocznikowy,
 - Szeregowo-bocznikowy

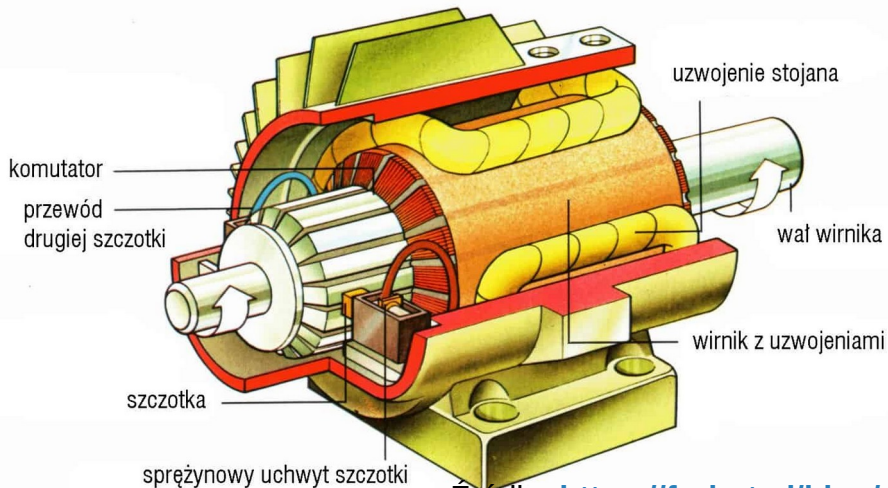

- Bezszczotkowe
 - BLDC
- Silniki krokowe
 - Bipolarne
 - Unipolarne

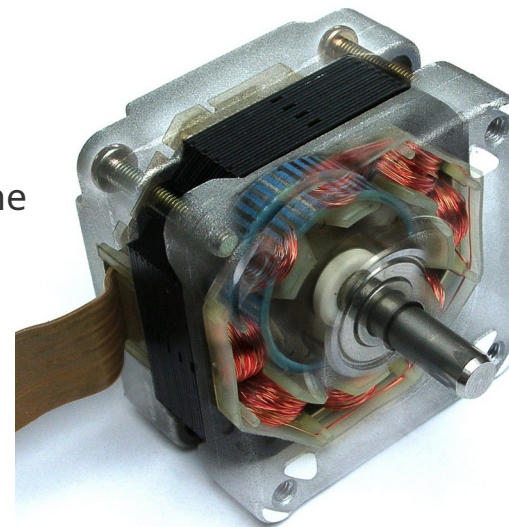
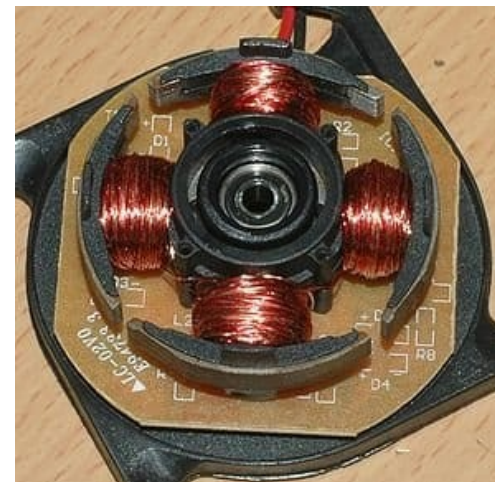

Jak działa silnik elektryczny?

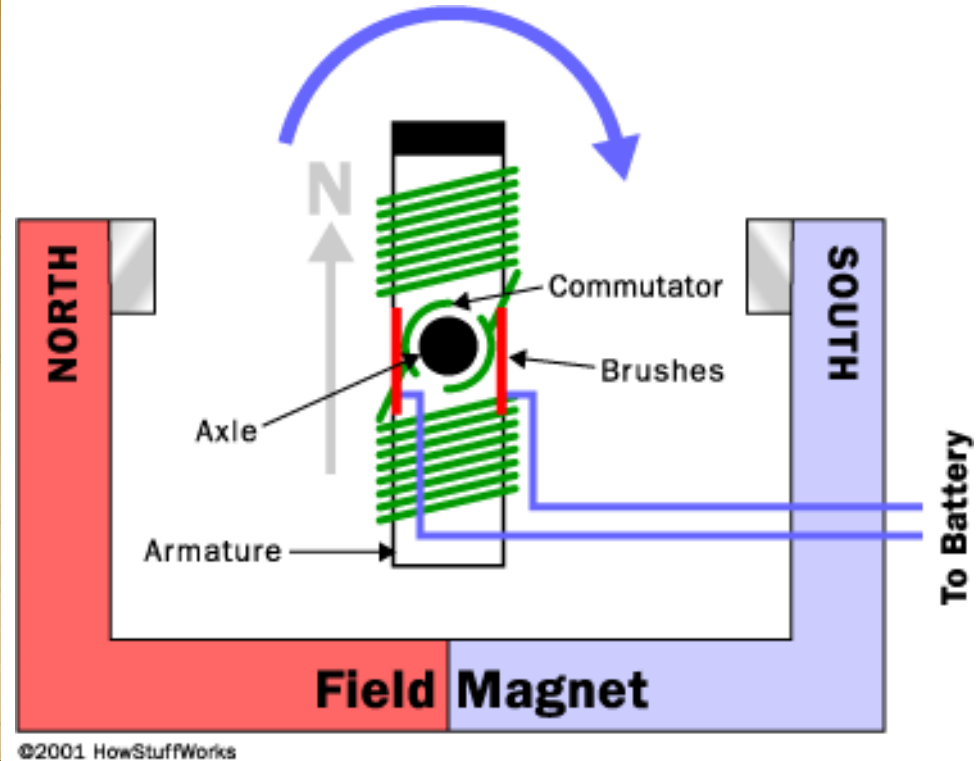
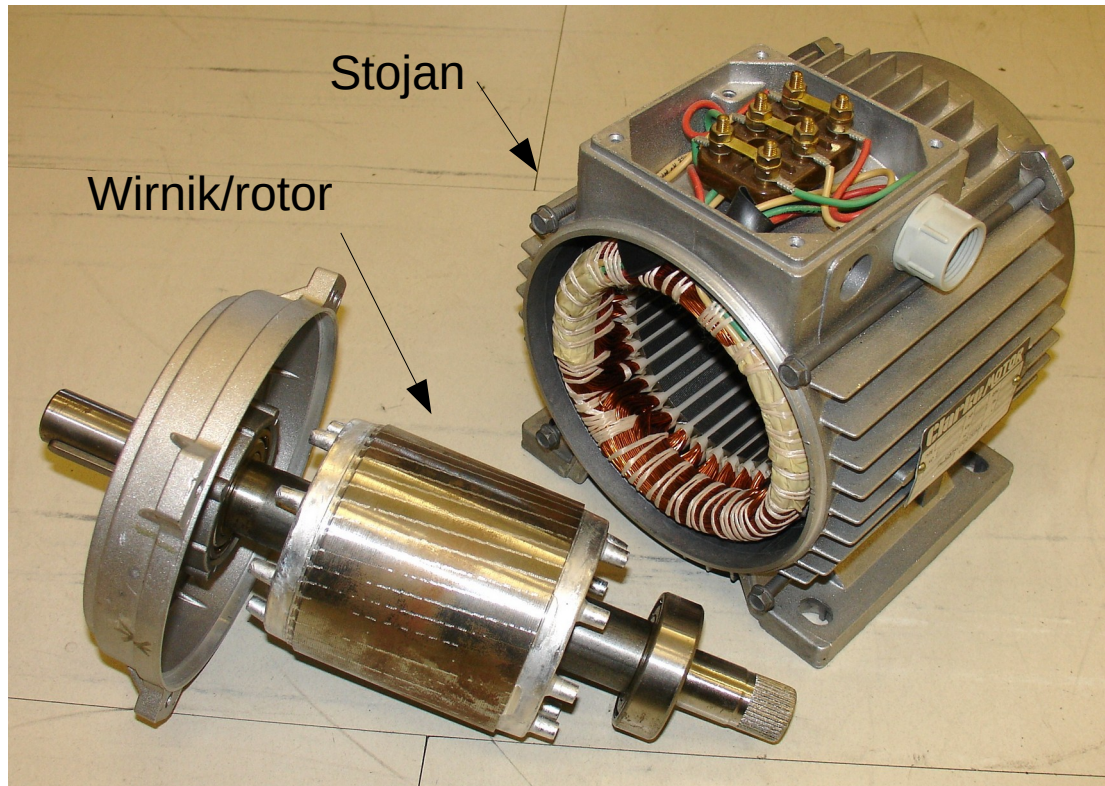

Silnik szczotkowy (komutatorowy)

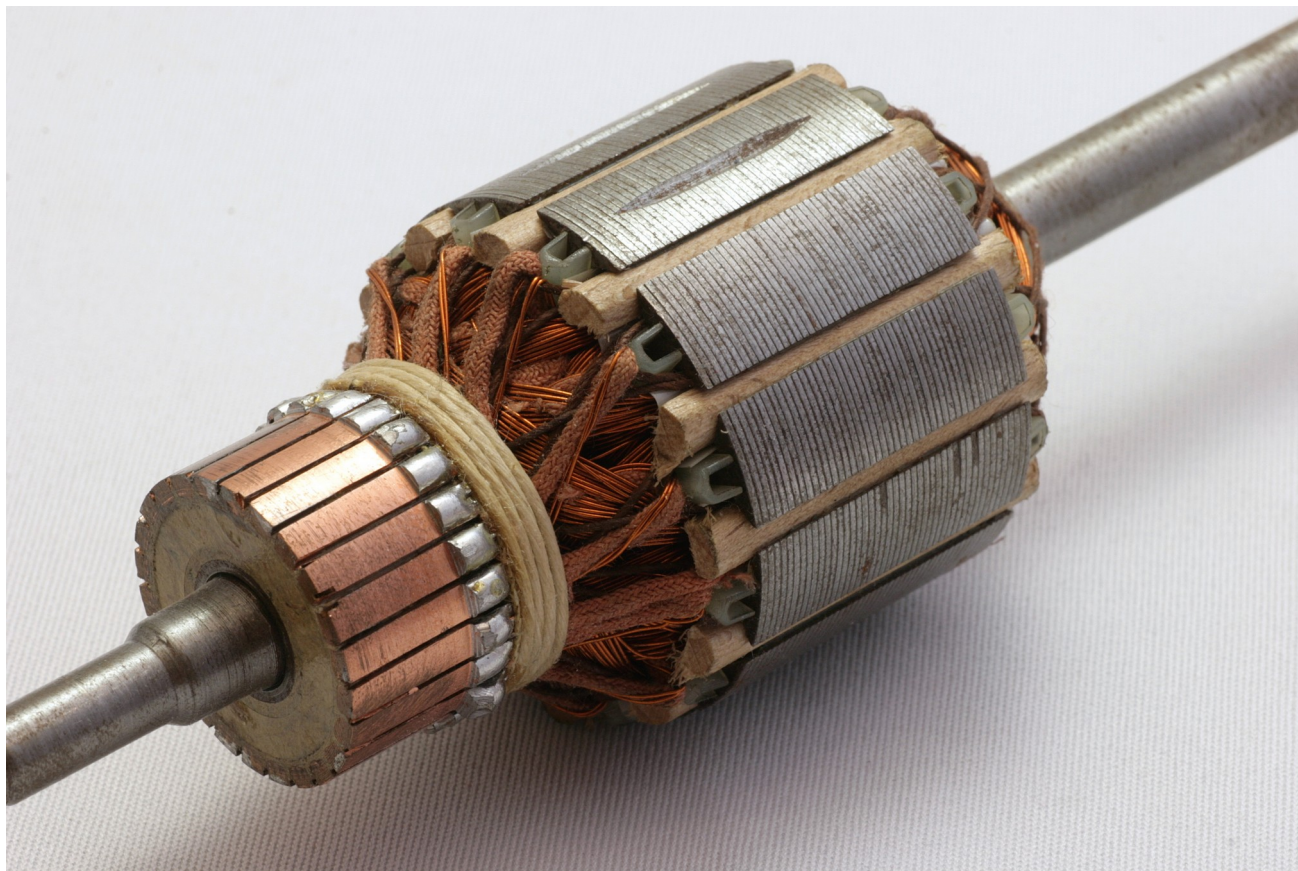
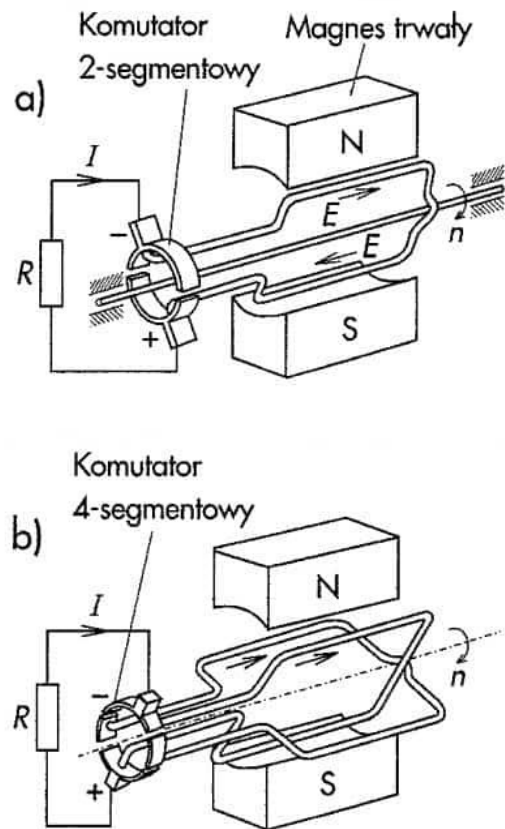

Zmiana prędkości silnika komutatorowego?

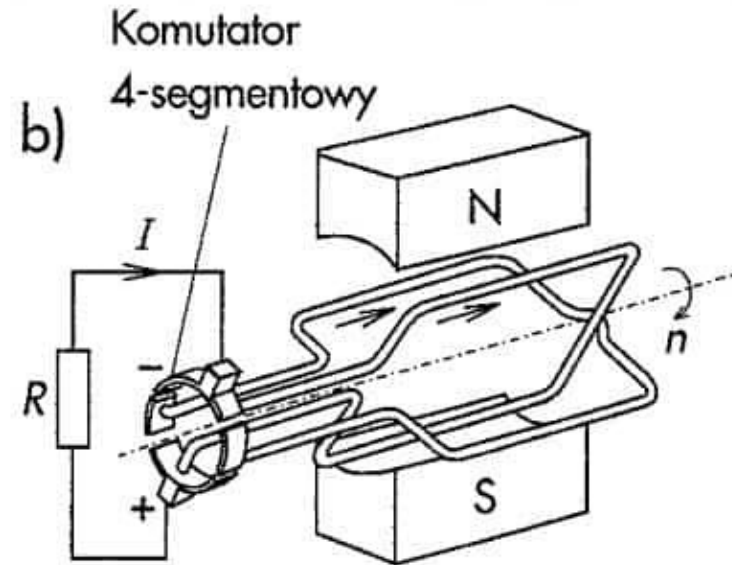
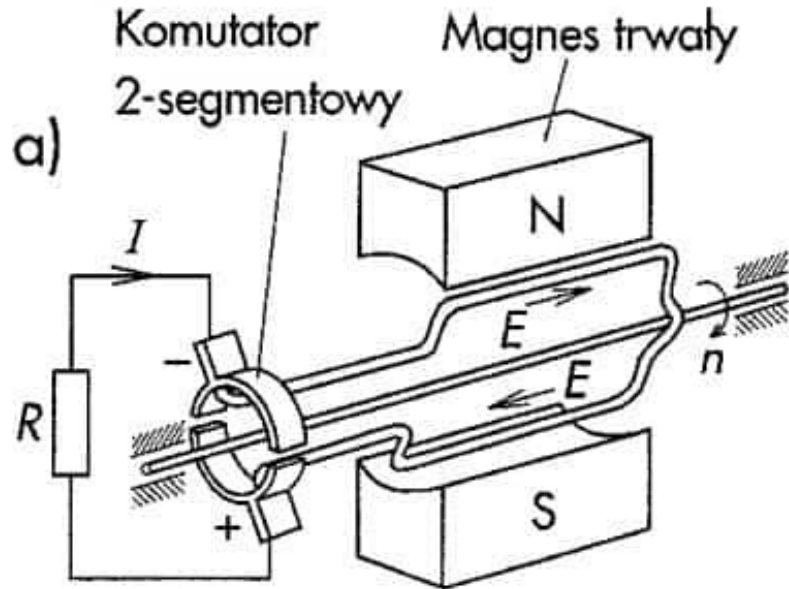

Silnik trójfazowy

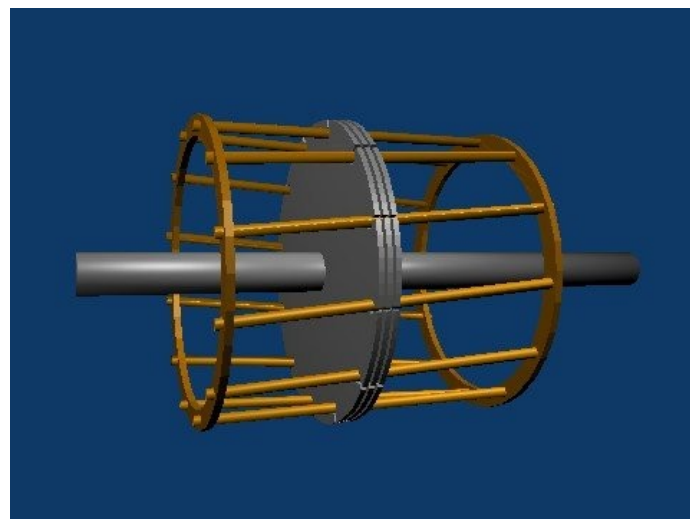
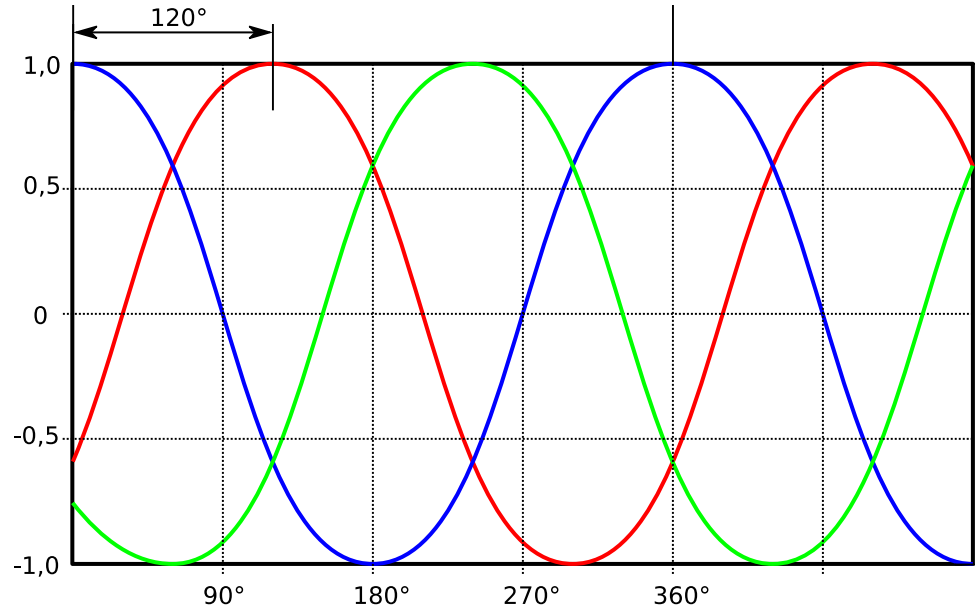
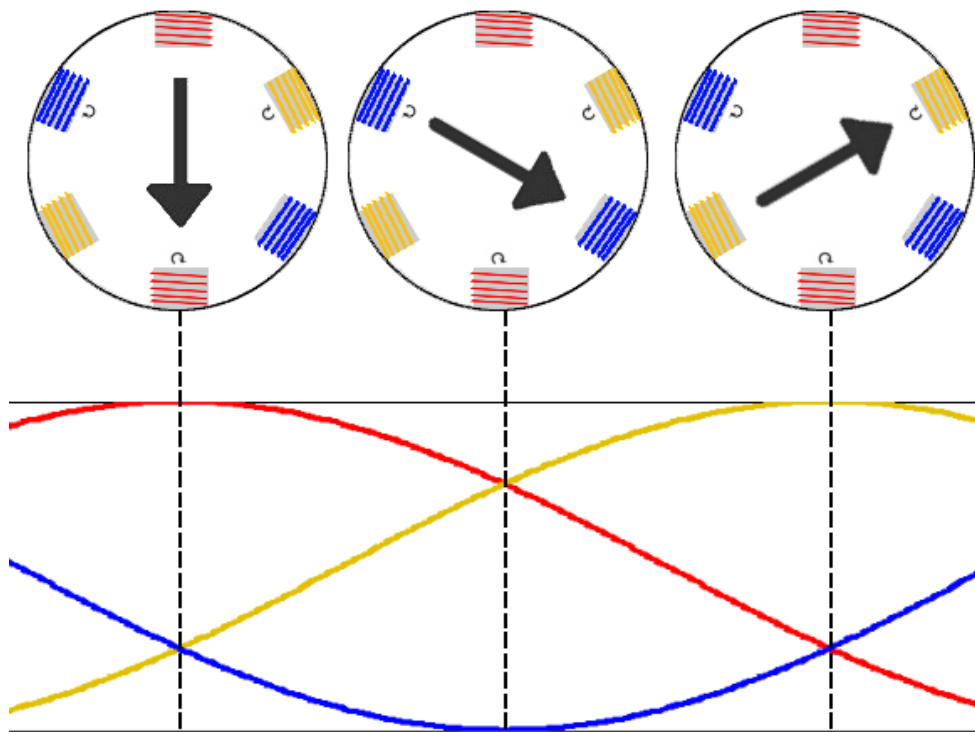

Źródła:

https://en.wikipedia.org/wiki/Induction_motor
https://en.wikipedia.org/wiki/Squirrel-cage_rotor

Zmiana prędkości silnika AC?

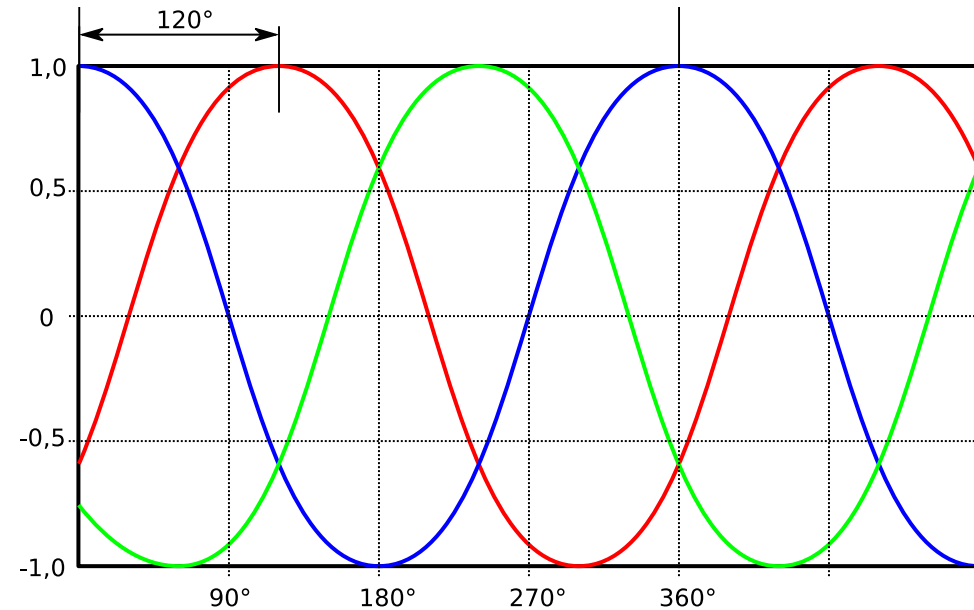
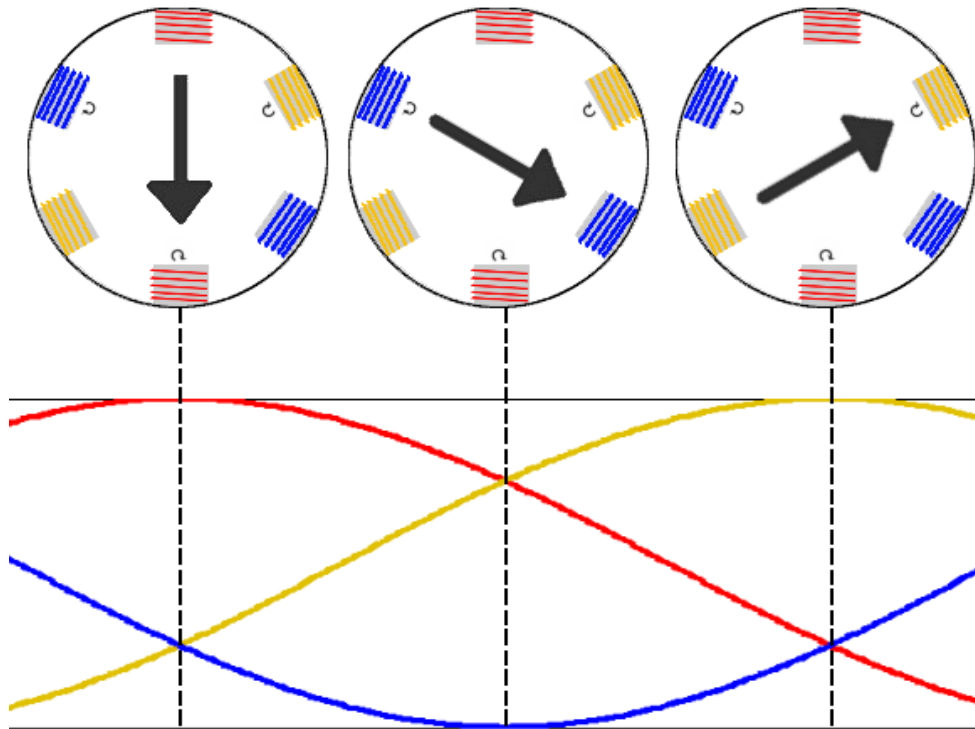

Przeмиennik częstotliwości (falownik)

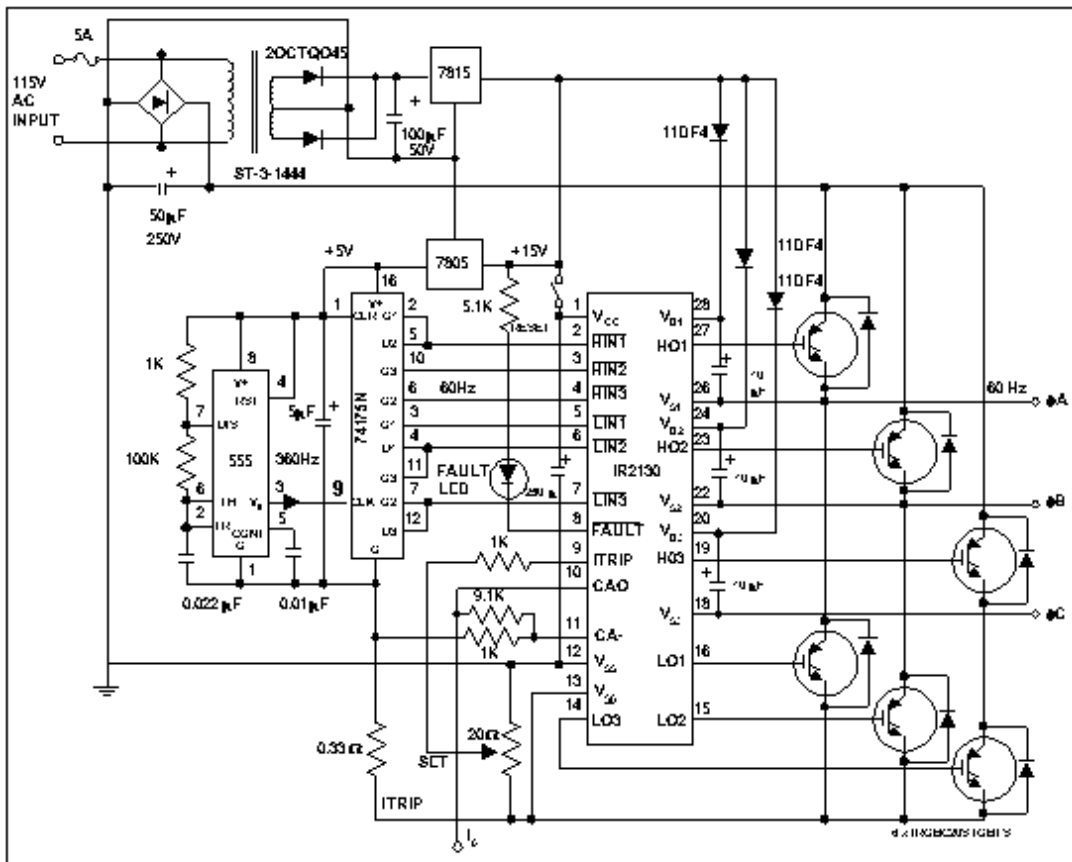
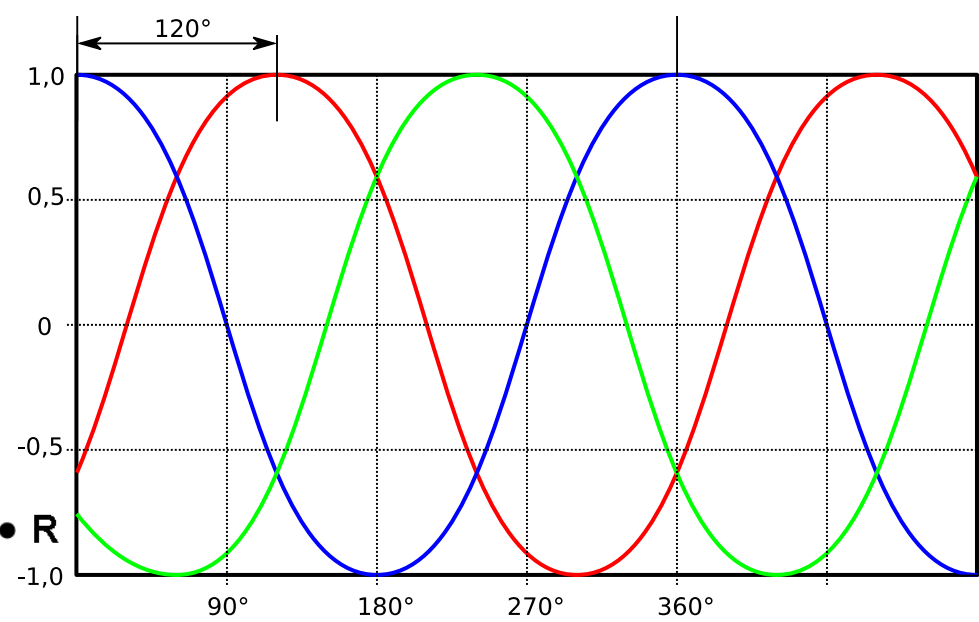
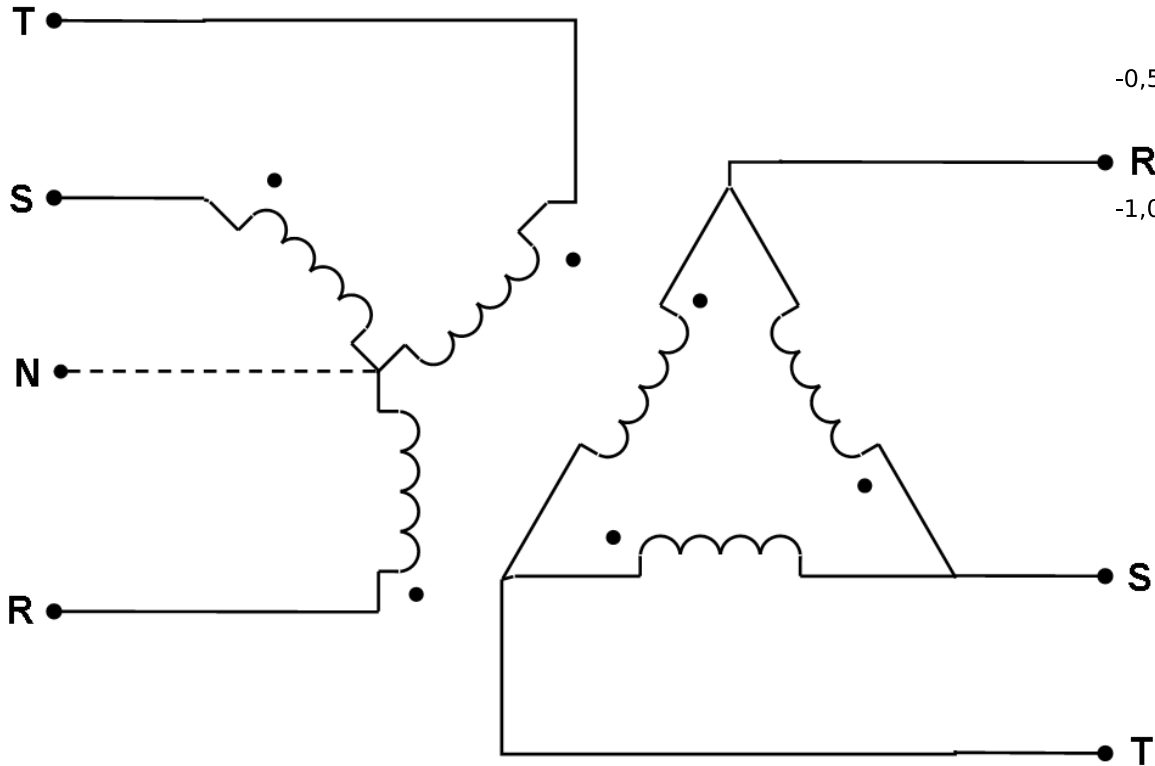

Figure 7. Three-phase six-step motor drive and 6 x HFA04TB60 [®] HEXFRED diodes



Trójkąt i gwiazda



Silniki krokowe

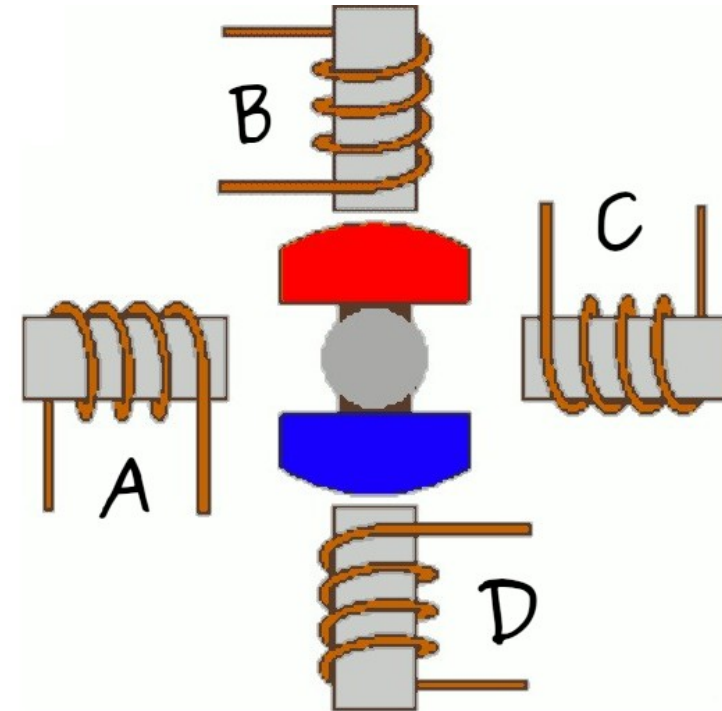

Źródła:

<https://www.serwis-elektroniki.com.pl/3066-2/>

<https://learn.adafruit.com/assets/16205>

Film!

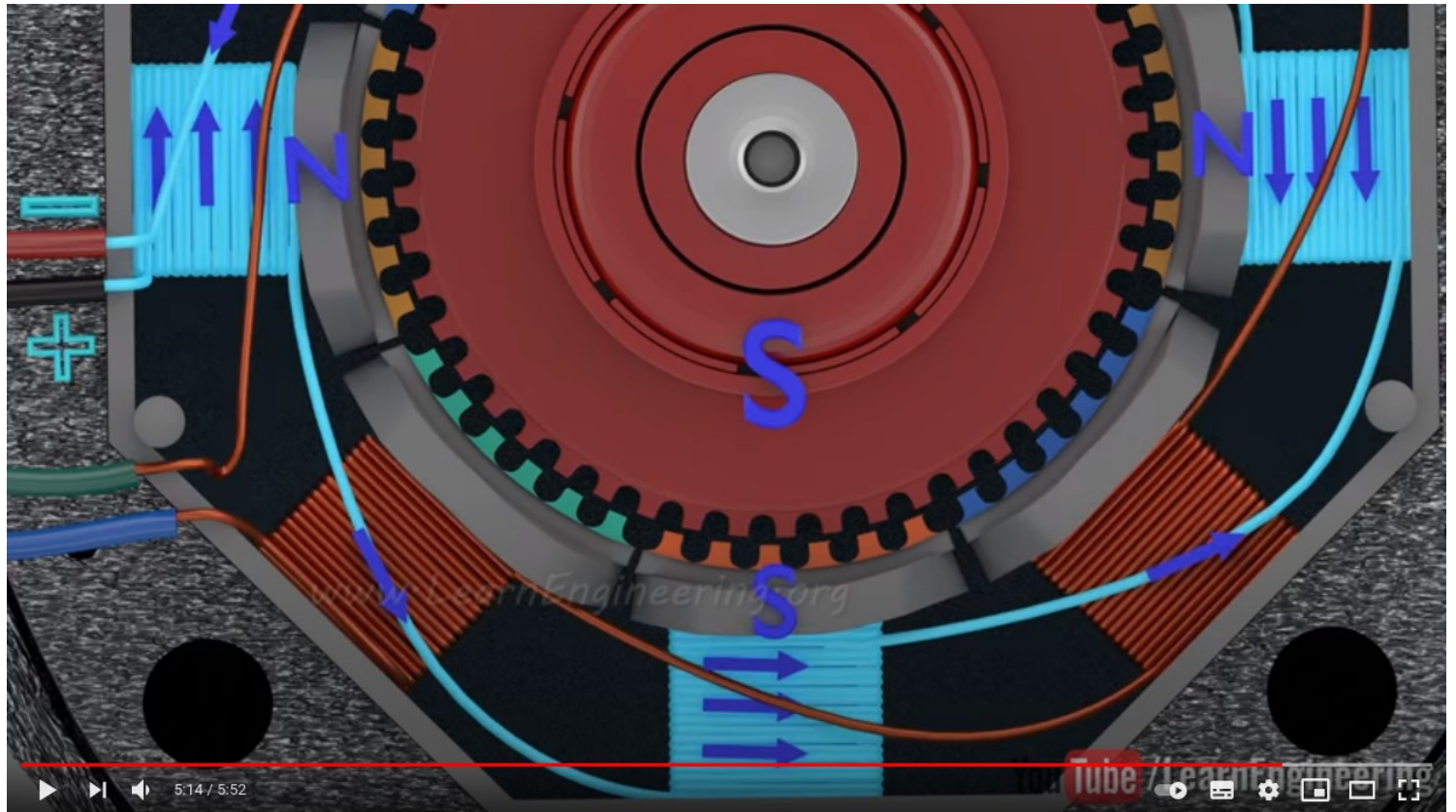

How does a Stepper Motor work ?

Pełne kroki w silnikach krokowych

1.

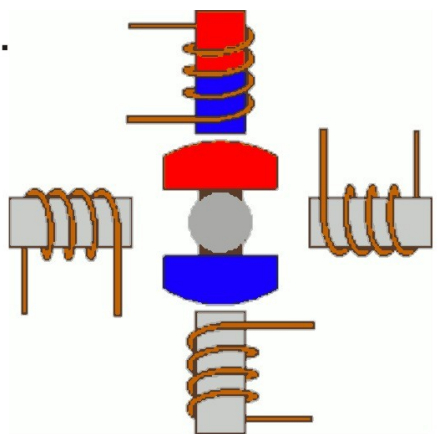

2.

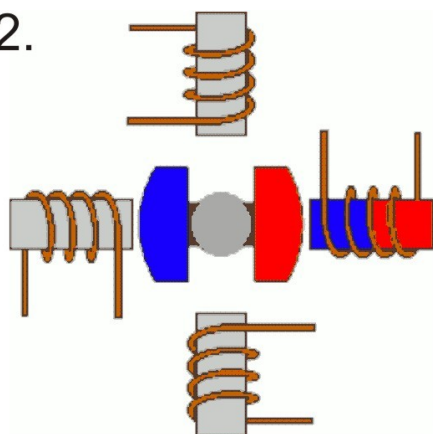

3.

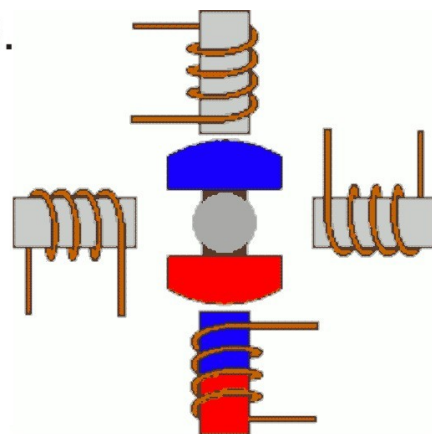

4.

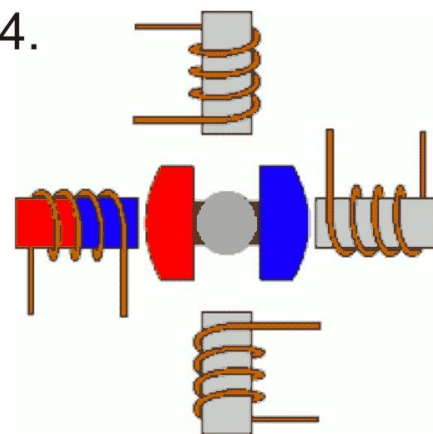

Jak zwiększyć precyzję?

Budowa silnika krokowego

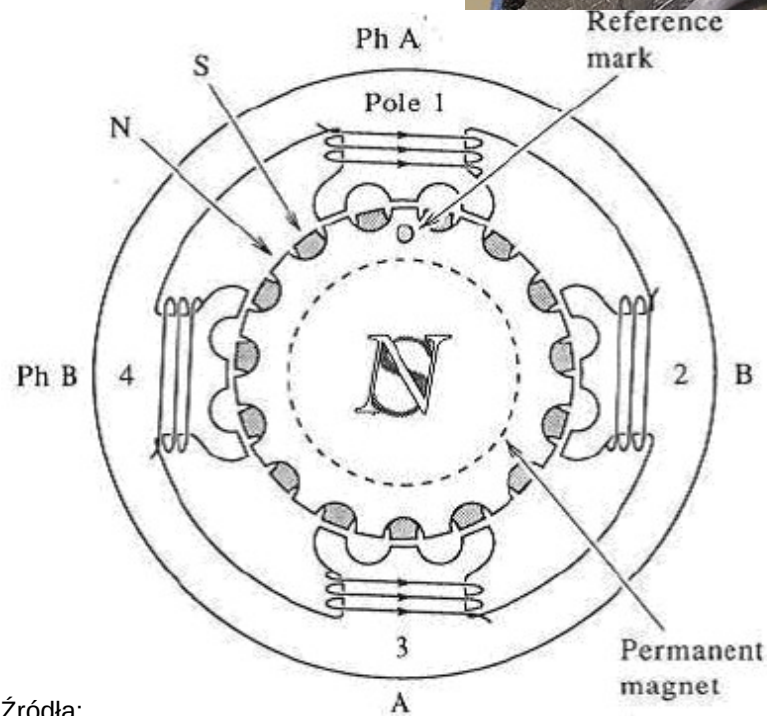
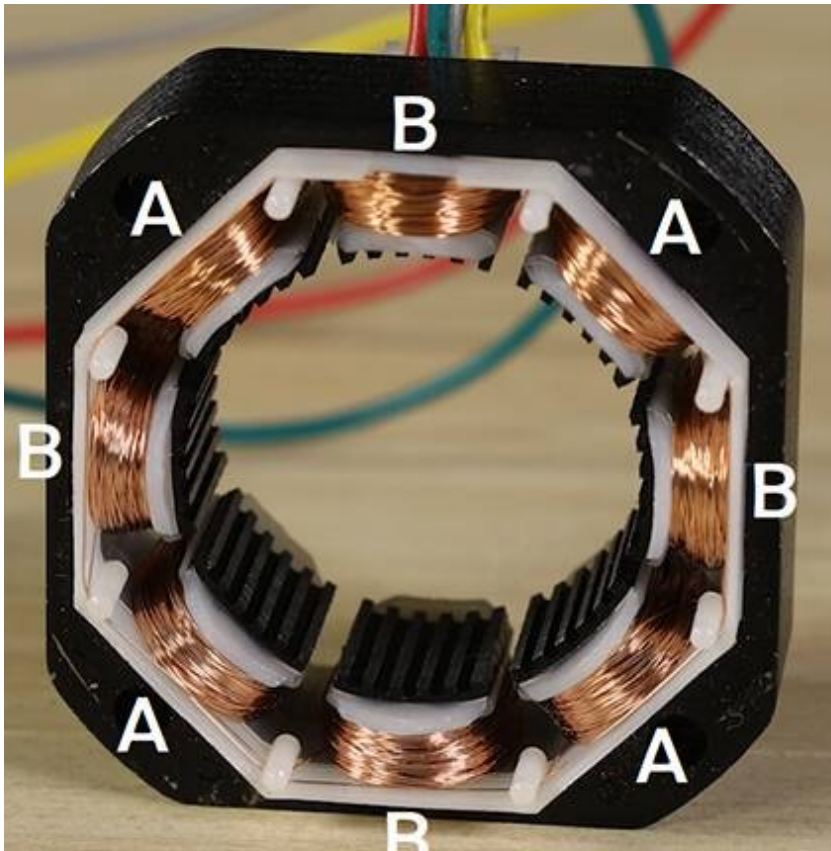
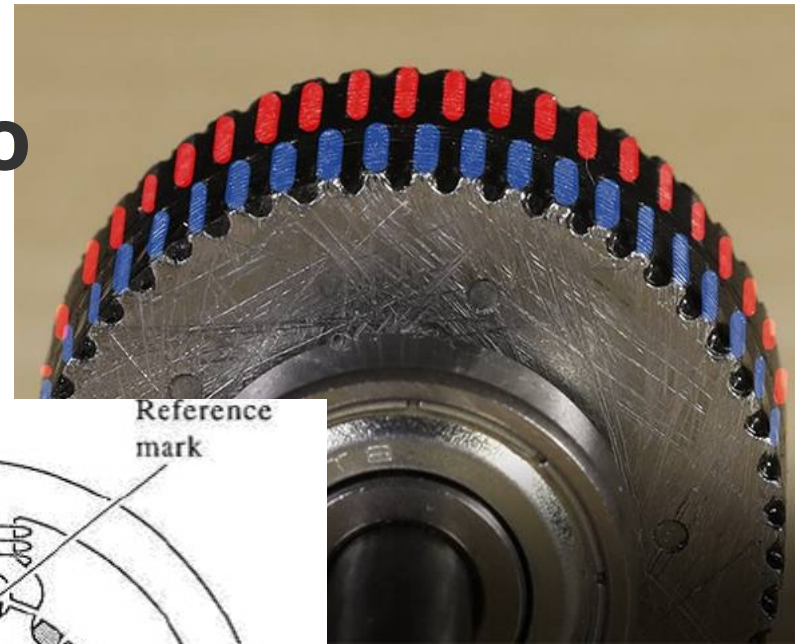

Źródła:

<https://www.digikey.pl/pl/blog/the-basics-of-stepper-motors>

<http://jntuimplab.blogspot.com/2008/01/interfacing-stepper-motor-to-8086-using.html>

Silnik krokowy, liniowy

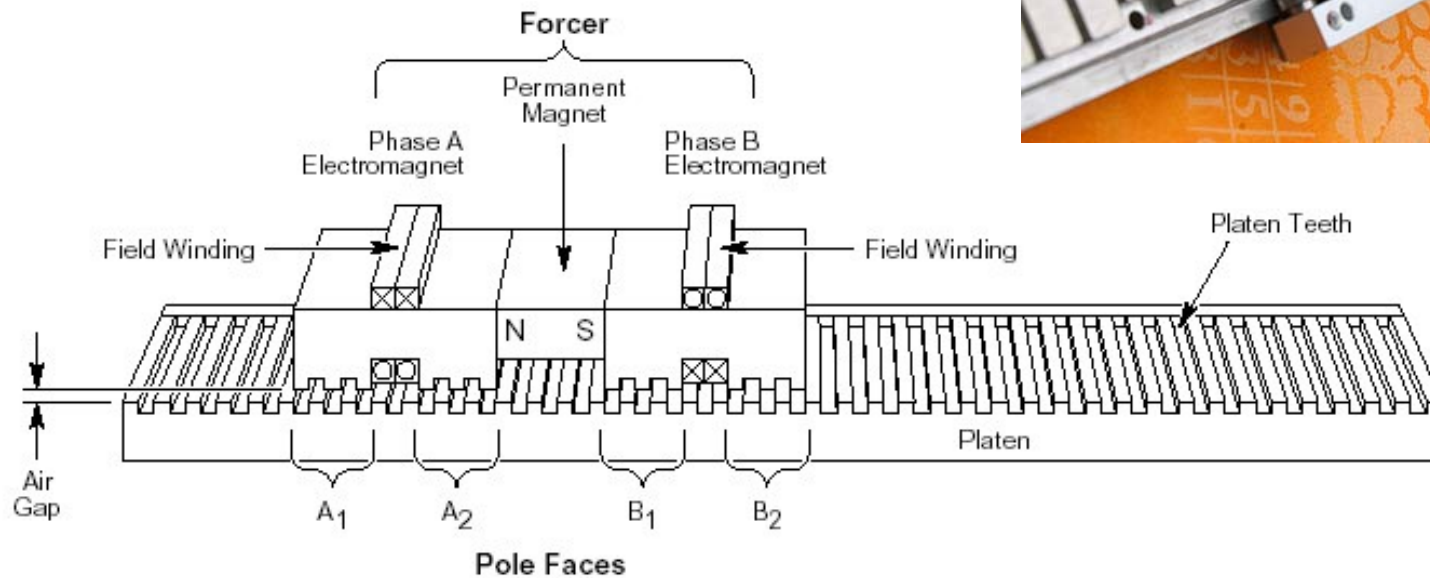

Silniki bezszczotkowe

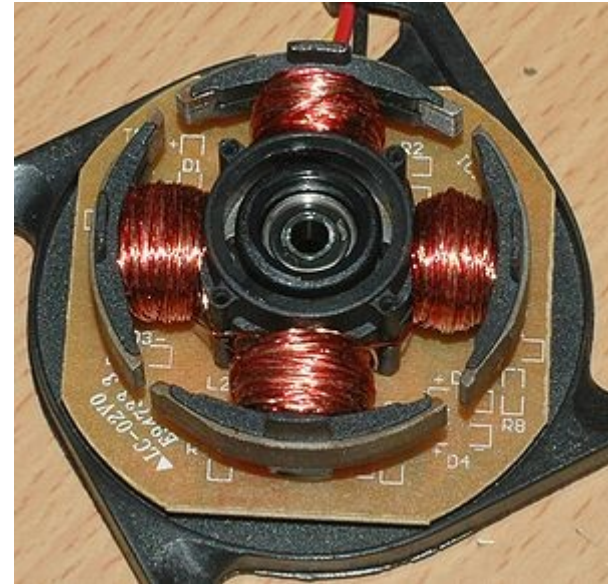

Serwonapęd

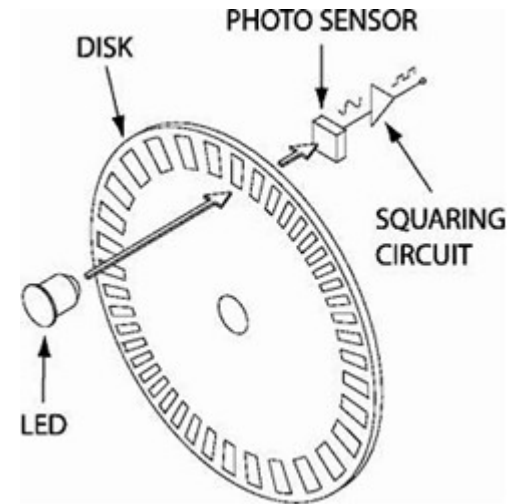
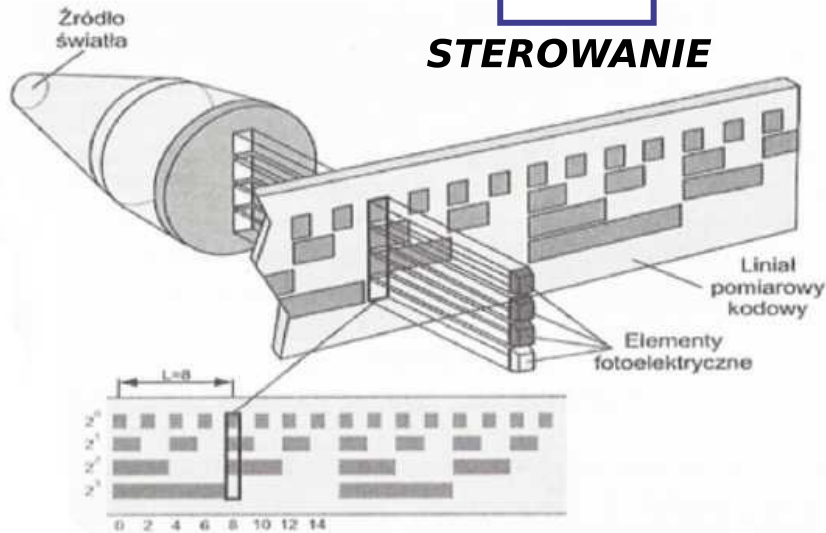
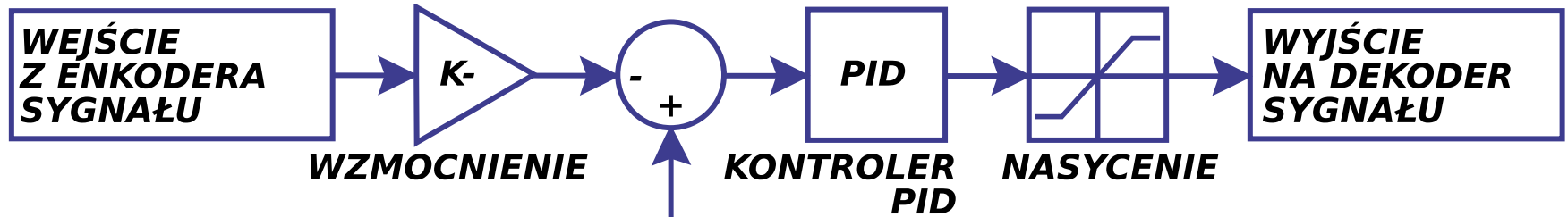

Źródła:

<http://www.asimo.pl/teoria/enkodery.php>

<https://pl.wikipedia.org/wiki/Serwomechanizm>

<https://www.ebmia.pl/wiedza/porady/automatyka-porady/enkoder/>

Prądnica

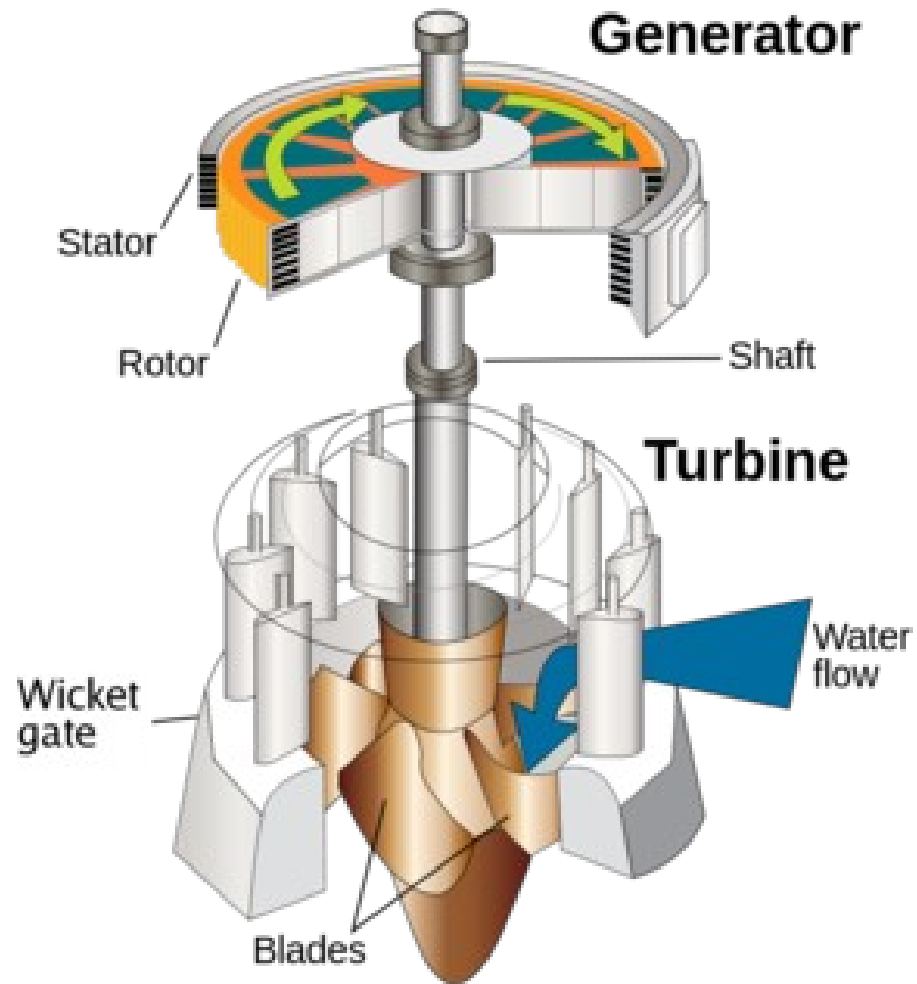
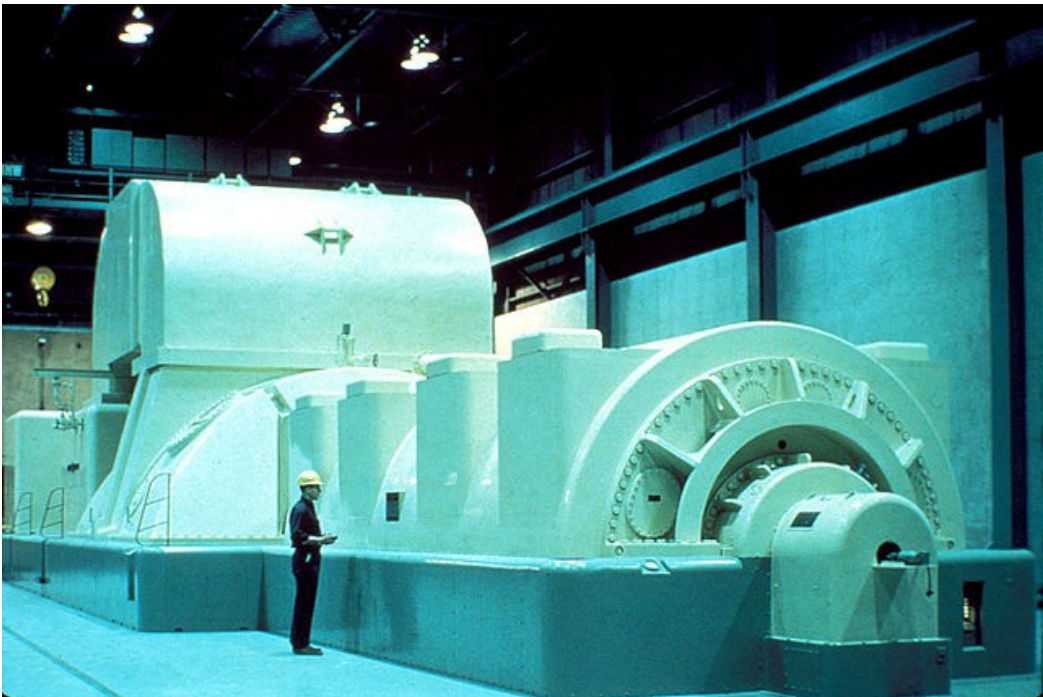

Czytanie kart charakterystyki

LED: 334-15/T1C1-4WYA

Absolute Maximum Ratings (Ta=25°C)

Parameter	Symbol	Rating	Unit
Continuous Forward Current	I _F	30	mA
Peak Forward Current(Duty /10 @ 1KHZ)	I _{FP}	100	mA
Reverse Voltage	V _R	5	V
Operating Temperature	T _{opr}	-40 ~ +85	°C
Storage Temperature	T _{stg}	-40 ~ +100	°C
Soldering Temperature (T=5 sec)	T _{sol}	260 ± 5	°C
Power Dissipation	P _d	100	mW
Zener Reverse Current	I _z	100	mA
Electrostatic Discharge	ESD	4K	V

Electro-Optical Characteristics (Ta=25°C)

Parameter	Symbol	Condition	Min.	Typ.	Max.	Units
Forward Voltage	V _F	I _F =20mA	3.0	----	3.6	V
Zener Reverse Voltage	V _Z	I _Z =5mA	5.2	----	----	V
Reverse Current	I _R	V _R =5V	----	----	50	uA
Luminous Intensity	I _v	I _F =20mA	14250	----	28500	mcd
Viewing Angle	2 θ 1/2	I _F =20mA	----	15	----	deg
Chromaticity Coordinates	x	I _F =20mA	----	0.30	----	
	y		----	0.29	----	

Czytanie kart charakterystyki

Przycisk: PTS645-S

S STRAIGHT

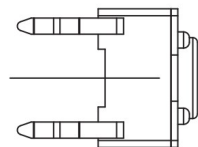
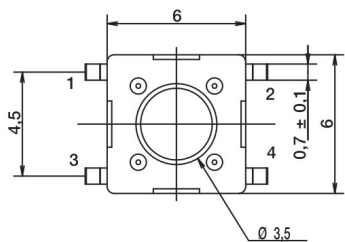
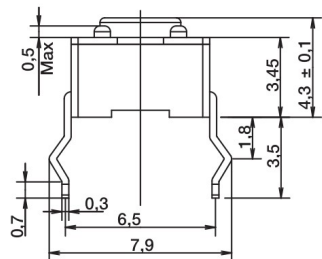

SCHMATIC

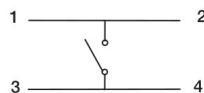

PCB LAYOUT

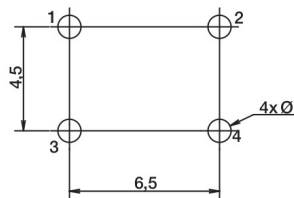

Tactile Switches

Specification

FUNCTION: Momentary action
CONTACT ARRANGEMENT: SPST, N.O.
TERMINALS: PC pins

Mechanical

ACTUATION FORCE: 130 grams, 160 grams, 200 grams, 260 grams
LIFE EXPECTANCY: 100,000 operations.

Electrical

CONTACT RATING: 50 mA @ 12 V DC.
DIELECTRIC STRENGTH: 250 V AC min.
CONTACT RESISTANCE: 100 mΩ max. initial.
INSULATION RESISTANCE: 10^{11} Ω min.

Environmental

OPERATING TEMPERATURE: -20°C to 60°C

Czytanie kart charakterystyki



Absolute Maximum Ratings $T_a=25^{\circ}\text{C}$ unless otherwise noted

Symbol	Parameter	Value	Units
V_{CBO}	Collector-Base Voltage : BC546	80	V
	: BC547/550	50	V
	: BC548/549	30	V
V_{CEO}	Collector-Emitter Voltage : BC546	65	V
	: BC547/550	45	V
	: BC548/549	30	V
V_{EBO}	Emitter-Base Voltage : BC546/547	6	V
	: BC548/549/550	5	V
I_{C}	Collector Current (DC)	100	mA
P_{C}	Collector Power Dissipation	500	mW
T_{J}	Junction Temperature	150	$^{\circ}\text{C}$
T_{STG}	Storage Temperature	-65 ~ 150	$^{\circ}\text{C}$

Czytanie kart charakterystyk

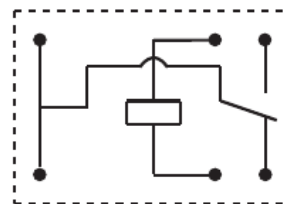

Przełącznik: HFD41

CONTACT DATA

Concat arrangement	1C
Contact resistance	100mΩ max. (at 1A 6VDC)
Contact material	AgNi, AgCdO
Contact rating (Res. load)	1A 120VAC, 1A 240VAC / 30VDC 3A 120VAC 2A 120VAC, 5A 120VAC
Max. switching voltage	240VAC / 30VDC
Max. switching current	5A
Max. switching power	600VA / 30W
Mechanical endurance	1 x 10 ⁷ OPS
Electrical endurance	9.9 x 10 ⁴ OPS (1A 120VAC, 1A 30VDC, Resistive load, Room temp., 1s on 9s off)

COIL DATA at 23°C

Nominal Voltage VDC	Pick-up Voltage VDC max.	Drop-out Voltage VDC min.	Max. Voltage VDC	Coil Resistance x (1±10%) Ω		
				H	N	B
3	2.3	0.3	3.9	45	25	20
5	3.8	0.5	6.5	120	70	56
6	4.5	0.6	7.8	180	100	80
9	6.8	0.9	11.7	400	220	180
12	9.0	1.2	15.6	700	400	320
24	18.0	2.4	31.2	2800	1600	1280